

# Expert Sleepers

***SUPER***  
***disting***  
***EX*** ***PLUS***  
***α***

**Firmware v1.19**  
**User Manual**

Copyright © 2023 Expert Sleepers Ltd. All rights reserved.

This manual, as well as the hardware and software described in it, is furnished under licence and may be used or copied only in accordance with the terms of such licence. The content of this manual is furnished for informational use only, is subject to change without notice, and should not be construed as a commitment by Expert Sleepers Ltd. Expert Sleepers Ltd assumes no responsibility or liability for any errors or inaccuracies that may appear in this document.

# Table of Contents

|  |                    |                                 |                    |
|--|--------------------|---------------------------------|--------------------|
| Introduction.....                            | <a href="#">7</a>  | Bulk operations.....            | <a href="#">22</a> |
| A note on videos.....                        | <a href="#">7</a>  | Load all from SD card.....      | <a href="#">22</a> |
| A note on navigating this manual.....        | <a href="#">7</a>  | Save all to SD card.....        | <a href="#">22</a> |
| Extra Content.....                           | <a href="#">7</a>  | Load from folder to.....        | <a href="#">22</a> |
| Installation.....                            | <a href="#">8</a>  | Save all to folder.....         | <a href="#">22</a> |
| Power requirements.....                      | <a href="#">8</a>  | Load all dual from SD.....      | <a href="#">23</a> |
| Connecting expansion modules.....            | <a href="#">8</a>  | Save all dual to SD.....        | <a href="#">23</a> |
| Jumpers.....                                 | <a href="#">9</a>  | Set preset mapping.....         | <a href="#">23</a> |
| Inputs and Outputs.....                      | <a href="#">10</a> | Auto-save.....                  | <a href="#">23</a> |
| Controls.....                                | <a href="#">10</a> | Mappings.....                   | <a href="#">24</a> |
| A note on the pots.....                      | <a href="#">10</a> | Web-based editor.....           | <a href="#">24</a> |
| Menus.....                                   | <a href="#">10</a> | CV Mappings.....                | <a href="#">24</a> |
| SD Card slot.....                            | <a href="#">11</a> | Knob Mappings.....              | <a href="#">25</a> |
| Inserting a MicroSD card.....                | <a href="#">11</a> | Button Mappings.....            | <a href="#">25</a> |
| Supported MicroSD cards.....                 | <a href="#">11</a> | MIDI Mappings.....              | <a href="#">26</a> |
| Overview.....                                | <a href="#">13</a> | I2C Mappings.....               | <a href="#">27</a> |
| Single Mode.....                             | <a href="#">13</a> | Load mapping.....               | <a href="#">28</a> |
| Single mode concepts.....                    | <a href="#">13</a> | Save mapping.....               | <a href="#">28</a> |
| Single mode display & controls.....          | <a href="#">13</a> | Reset mapping.....              | <a href="#">28</a> |
| Parameters with confirm.....                 | <a href="#">14</a> | Name mapping.....               | <a href="#">28</a> |
| Display zoom.....                            | <a href="#">15</a> | Load from SD card.....          | <a href="#">28</a> |
| Single mode common parameters.....           | <a href="#">15</a> | Save to SD card.....            | <a href="#">29</a> |
| Single mode help.....                        | <a href="#">15</a> | Load all from SD card.....      | <a href="#">29</a> |
| Dual Mode.....                               | <a href="#">16</a> | Save all to SD card.....        | <a href="#">29</a> |
| disting mk4 firmware version.....            | <a href="#">16</a> | Single Mode Algorithms.....     | <a href="#">30</a> |
| Sample rate.....                             | <a href="#">16</a> | 1 – Matrix Mixer.....           | <a href="#">31</a> |
| Scala support.....                           | <a href="#">16</a> | Parameters.....                 | <a href="#">31</a> |
| Favourites.....                              | <a href="#">16</a> | Quantization options.....       | <a href="#">32</a> |
| Help.....                                    | <a href="#">17</a> | 2 – Augustus Loop.....          | <a href="#">33</a> |
| Z push functions & the Knob Recorder.....    | <a href="#">17</a> | Algorithm-specific display..... | <a href="#">34</a> |
| disting mk4 algorithms not included.....     | <a href="#">17</a> | Outputs.....                    | <a href="#">34</a> |
| disting mk4 algorithms with improved         |                    | Parameters.....                 | <a href="#">34</a> |
| specifications.....                          | <a href="#">18</a> | Default mappings.....           | <a href="#">37</a> |
| Extra algorithms not part of the disting mk4 |                    | Delay time multipliers.....     | <a href="#">37</a> |
| .....  | <a href="#">19</a> | Tap tempo.....                  | <a href="#">37</a> |
| Entering dual mode.....                      | <a href="#">19</a> | Clocks required.....            | <a href="#">37</a> |
| Accessing the main menu from dual mode.....  | <a href="#">19</a> | Inertia free mode.....          | <a href="#">38</a> |
| Presets in dual mode.....                    | <a href="#">19</a> | Filter.....                     | <a href="#">38</a> |
| Dual display modes.....                      | <a href="#">19</a> | Effects Loop.....               | <a href="#">38</a> |
| Presets.....                                 | <a href="#">20</a> | 3 – SD Multisample.....         | <a href="#">39</a> |
| Web-based preset editor.....                 | <a href="#">20</a> | Algorithm-specific display..... | <a href="#">39</a> |
| Load preset.....                             | <a href="#">21</a> | Inputs.....                     | <a href="#">40</a> |
| Save preset.....                             | <a href="#">21</a> | Outputs.....                    | <a href="#">40</a> |
| Reset preset.....                            | <a href="#">21</a> | MIDI support.....               | <a href="#">41</a> |
| Name preset.....                             | <a href="#">21</a> | All notes off.....              | <a href="#">41</a> |
| Erase preset.....                            | <a href="#">21</a> | Parameters.....                 | <a href="#">41</a> |
| Load from SD card.....                       | <a href="#">21</a> | Default mappings.....           | <a href="#">44</a> |
| Save to SD card.....                         | <a href="#">22</a> | Note ranges.....                | <a href="#">45</a> |

|  |                    |                                     |                    |
|--|--------------------|-------------------------------------|--------------------|
| Tap tempo.....   | <a href="#">45</a> | Overdub fade.....                   | <a href="#">68</a> |
| Chord scales.....  | <a href="#">45</a> | Replace.....                        | <a href="#">68</a> |
| Chord shapes.....  | <a href="#">46</a> | Clocked operation.....              | <a href="#">68</a> |
| Arpeggio modes.....  | <a href="#">47</a> | ES-5 outputs.....                   | <a href="#">68</a> |
| Chords, arpeggios, and multiple CV inputs<br>per gate..... | <a href="#">48</a> | MIDI support.....                   | <a href="#">68</a> |
| WAV file defaults.....                                     | <a href="#">48</a> | Parameters.....                     | <a href="#">69</a> |
| Scala and MTS (MIDI Tuning Standard)<br>support.....       | <a href="#">48</a> | Default mappings.....               | <a href="#">70</a> |
| SoundFont®s.....   | <a href="#">50</a> | Saving/loading loops.....           | <a href="#">71</a> |
| Creating your own multisamples.....                        | <a href="#">50</a> | 8 – Dream Machine.....              | <a href="#">73</a> |
| Transpose limit.....                                       | <a href="#">50</a> | Setting the fundamental.....        | <a href="#">73</a> |
| Broken chords.....   | <a href="#">51</a> | Setting the primes.....             | <a href="#">74</a> |
| Round robin mode.....                                      | <a href="#">51</a> | Setting the frequency ratios.....   | <a href="#">74</a> |
| 4 – SD 6 Triggers.....                                     | <a href="#">52</a> | Outputs.....                        | <a href="#">74</a> |
| Algorithm-specific display.....                            | <a href="#">52</a> | Parameters.....                     | <a href="#">74</a> |
| Outputs.....   | <a href="#">53</a> | Default mappings.....               | <a href="#">75</a> |
| ES-5 outputs.....  | <a href="#">53</a> | Fun fact.....                       | <a href="#">76</a> |
| Trigger inputs.....  | <a href="#">53</a> | 9 – Filter Bank.....                | <a href="#">77</a> |
| MIDI support.....  | <a href="#">53</a> | Filter modes.....                   | <a href="#">77</a> |
| All notes off/all sound off.....                           | <a href="#">53</a> | Setting the filter frequencies..... | <a href="#">78</a> |
| Parameters.....  | <a href="#">53</a> | Outputs.....                        | <a href="#">78</a> |
| WAV file defaults.....                                     | <a href="#">54</a> | MIDI support.....                   | <a href="#">78</a> |
| 5 – WAV Recorder.....                                      | <a href="#">55</a> | Parameters.....                     | <a href="#">78</a> |
| Recording.....   | <a href="#">55</a> | Default mappings.....               | <a href="#">79</a> |
| Multi-channel audio.....                                   | <a href="#">56</a> | 10 – Poly Wavetable.....            | <a href="#">80</a> |
| Algorithm-specific display.....                            | <a href="#">56</a> | Algorithm-specific display.....     | <a href="#">80</a> |
| Outputs.....   | <a href="#">56</a> | Inputs.....                         | <a href="#">81</a> |
| Parameters.....  | <a href="#">57</a> | Outputs.....                        | <a href="#">81</a> |
| Default mappings.....                                      | <a href="#">58</a> | MIDI support.....                   | <a href="#">82</a> |
| Output options.....  | <a href="#">58</a> | All notes off.....                  | <a href="#">82</a> |
| Auto-sampler.....  | <a href="#">58</a> | Parameters.....                     | <a href="#">82</a> |
| 6 – Multi-Switch.....                                      | <a href="#">60</a> | Default mappings.....               | <a href="#">86</a> |
| Parameters.....  | <a href="#">60</a> | Output modes.....                   | <a href="#">86</a> |
| Default mappings.....                                      | <a href="#">61</a> | Tap tempo.....                      | <a href="#">86</a> |
| Inputs choices.....  | <a href="#">62</a> | Chords and arpeggiators.....        | <a href="#">86</a> |
| Outputs choices.....                                       | <a href="#">62</a> | Scala and MTS support.....          | <a href="#">87</a> |
| Control sources (when type is not 'Link').....             | <a href="#">62</a> | Trigger mode.....                   | <a href="#">87</a> |
| Control sources (when type is 'Link').....                 | <a href="#">63</a> | 11 – Granulator.....                | <a href="#">88</a> |
| Control types.....   | <a href="#">63</a> | Effects and routing.....            | <a href="#">89</a> |
| Reset sources.....   | <a href="#">64</a> | Algorithm-specific display.....     | <a href="#">89</a> |
| 7 – Looper.....  | <a href="#">65</a> | Outputs.....                        | <a href="#">90</a> |
| Loop targets and commands.....                             | <a href="#">65</a> | MIDI support.....                   | <a href="#">90</a> |
| Basic looping.....   | <a href="#">66</a> | Parameters.....                     | <a href="#">90</a> |
| Recording a blank loop.....                                | <a href="#">66</a> | Default mappings.....               | <a href="#">94</a> |
| Pausing/muting/retriggering the loop.....                  | <a href="#">67</a> | Spawn mode.....                     | <a href="#">94</a> |
| Overdubbing.....   | <a href="#">67</a> | Size mean '0'.....                  | <a href="#">95</a> |
| Clearing the loop.....                                     | <a href="#">67</a> | Pitch quantize.....                 | <a href="#">95</a> |
| Crossfades.....  | <a href="#">67</a> | Shape.....                          | <a href="#">96</a> |
| Envelopes.....   | <a href="#">68</a> | Saving/loading WAV files.....       | <a href="#">97</a> |
|  |                    | Viewing the WAV path.....           | <a href="#">97</a> |
|  |                    | Clearing the audio buffer.....      | <a href="#">98</a> |

|  |                     |  |                     |
|--|---------------------|--|---------------------|
| 12 – Multi FX.....   | <a href="#">99</a>  | Saving your recorded impulses.....                     | <a href="#">122</a> |
| Routing.....   | <a href="#">99</a>  | Live update.....                                       | <a href="#">122</a> |
| Algorithm-specific display.....  | <a href="#">100</a> | Outputs.....   | <a href="#">122</a> |
| EQ.....  | <a href="#">100</a> | Parameters.....  | <a href="#">122</a> |
| Pitch Effects.....   | <a href="#">100</a> | Default mappings.....                                  | <a href="#">123</a> |
| Delay.....   | <a href="#">100</a> | 16 – Chord Engine.....                                 | <a href="#">124</a> |
| Reverb.....  | <a href="#">101</a> | Chord mode.....  | <a href="#">124</a> |
| Variable Sample Rate.....  | <a href="#">101</a> | Harmony modes.....                                     | <a href="#">124</a> |
| Outputs.....   | <a href="#">101</a> | Distribution mode.....                                 | <a href="#">125</a> |
| Aux input.....   | <a href="#">101</a> | Algorithm-specific display.....                        | <a href="#">125</a> |
| MIDI support.....  | <a href="#">101</a> | Outputs.....   | <a href="#">125</a> |
| Parameters.....  | <a href="#">102</a> | ES-5 outputs.....                                      | <a href="#">125</a> |
| Default mappings.....  | <a href="#">105</a> | MIDI support.....                                      | <a href="#">126</a> |
| 13 – Poly Exciter.....   | <a href="#">106</a> | Parameters.....  | <a href="#">126</a> |
| What is an 'exciter'?.....   | <a href="#">106</a> | Default mappings.....                                  | <a href="#">128</a> |
| Built-in exciters.....   | <a href="#">107</a> | Chords and arpeggiators.....                           | <a href="#">128</a> |
| Exciter files on the MicroSD card.....   | <a href="#">107</a> | Scala and MTS support.....                             | <a href="#">129</a> |
| Processing external audio.....   | <a href="#">107</a> | Input and output transposition and fine<br>tuning..... | <a href="#">129</a> |
| Algorithm-specific display.....  | <a href="#">108</a> | Calibration.....                                       | <a href="#">129</a> |
| Outputs.....   | <a href="#">108</a> | MIDI output.....                                       | <a href="#">130</a> |
| MIDI support.....  | <a href="#">108</a> | 17 – Microtuner.....                                   | <a href="#">131</a> |
| All notes off.....   | <a href="#">108</a> | Algorithm-specific display.....                        | <a href="#">131</a> |
| Parameters.....  | <a href="#">109</a> | Outputs.....   | <a href="#">132</a> |
| Default mappings.....  | <a href="#">112</a> | Parameters.....  | <a href="#">132</a> |
| Excitation modes.....  | <a href="#">112</a> | Default mappings.....                                  | <a href="#">133</a> |
| Input modes.....   | <a href="#">112</a> | Scala and MTS support.....                             | <a href="#">133</a> |
| Output modes.....  | <a href="#">113</a> | 18 – Tracker.....                                      | <a href="#">134</a> |
| Tap tempo.....   | <a href="#">113</a> | Harmony modes.....                                     | <a href="#">134</a> |
| Chords and arpeggiators.....   | <a href="#">113</a> | Algorithm-specific display.....                        | <a href="#">135</a> |
| Scala and MTS support.....   | <a href="#">114</a> | Outputs.....   | <a href="#">135</a> |
| 14 – Quad Envelope.....  | <a href="#">115</a> | MIDI support.....                                      | <a href="#">136</a> |
| 'Shapes' and 'Envelopes'.....  | <a href="#">115</a> | Parameters.....  | <a href="#">136</a> |
| VCAs.....  | <a href="#">115</a> | Default mappings.....                                  | <a href="#">138</a> |
| Algorithm-specific display.....  | <a href="#">116</a> | Scala and MTS support.....                             | <a href="#">138</a> |
| Outputs.....   | <a href="#">116</a> | Calibration.....                                       | <a href="#">138</a> |
| ES-5 outputs.....  | <a href="#">116</a> | 19 – Macro Oscillator.....                             | <a href="#">140</a> |
| MIDI support.....  | <a href="#">117</a> | META mode.....   | <a href="#">140</a> |
| Parameters.....  | <a href="#">117</a> | Outputs.....   | <a href="#">141</a> |
| Default mappings.....  | <a href="#">118</a> | MIDI support.....                                      | <a href="#">141</a> |
| Press to trigger.....  | <a href="#">118</a> | Parameters.....  | <a href="#">141</a> |
| Input selection.....   | <a href="#">118</a> | Default mappings.....                                  | <a href="#">142</a> |
| Trigger modes.....   | <a href="#">118</a> | Settings.....  | <a href="#">142</a> |
| Clock inputs.....  | <a href="#">119</a> | 20 – Resonator.....                                    | <a href="#">144</a> |
| Clock modes.....   | <a href="#">119</a> | Input normalization.....                               | <a href="#">144</a> |
| 15 – Convolver.....  | <a href="#">120</a> | Outputs.....   | <a href="#">145</a> |
| Impulse length and the factors that affect it<br>.....   | <a href="#">120</a> | MIDI support.....                                      | <a href="#">145</a> |
| Impulse responses on the MicroSD card...<br>Recording impulse responses into the<br>algorithm..... | <a href="#">121</a> | Parameters.....  | <a href="#">145</a> |
|  |                     | Default mappings.....                                  | <a href="#">146</a> |
|  |                     | MIDI and I2C modes.....                                | <a href="#">146</a> |

|  |                     |  |                     |
|--|---------------------|--|---------------------|
| 21 – Macro Oscillator 2.....                   | <a href="#">147</a> | Show firmware version.....               | <a href="#">164</a> |
| Input normalization.....                       | <a href="#">147</a> | Reboot.....                              | <a href="#">164</a> |
| Outputs.....                                   | <a href="#">148</a> | Show MIDI history.....                   | <a href="#">164</a> |
| MIDI support.....                              | <a href="#">148</a> | Show I2C history.....                    | <a href="#">164</a> |
| Parameters.....                                | <a href="#">148</a> | Show stats.....                          | <a href="#">164</a> |
| Default mappings.....                          | <a href="#">149</a> | Save MTS dump to SD.....                 | <a href="#">164</a> |
| Settings.....                                  | <a href="#">149</a> | Tests.....                               | <a href="#">165</a> |
| Dual Mode Algorithms.....                      | <a href="#">151</a> | 5-pin DIN MIDI I/O.....                  | <a href="#">166</a> |
| H-2 Dual Sample and Hold.....                  | <a href="#">151</a> | Connections.....                         | <a href="#">166</a> |
| J-5 Oscilloscope.....                          | <a href="#">152</a> | MIDI "Low-Voltage Signaling".....        | <a href="#">166</a> |
| K-6 24dB/oct VCF.....                          | <a href="#">153</a> | MIDI System Exclusive (SysEx).....       | <a href="#">167</a> |
| K-7 Delay Stereo.....                          | <a href="#">153</a> | SysEx Header.....                        | <a href="#">167</a> |
| K-8 Delay Stereo Clk.....                      | <a href="#">153</a> | 16 bit values.....                       | <a href="#">167</a> |
| N-7 Frequency Shifter.....                     | <a href="#">154</a> | Received SysEx messages.....             | <a href="#">167</a> |
| N-8 Dual VCO.....                              | <a href="#">156</a> | Sent SysEx messages.....                 | <a href="#">170</a> |
| WAV file naming conventions and playlists..... | <a href="#">157</a> | Select Bus.....                          | <a href="#">173</a> |
| Per-algorithm defaults.....                    | <a href="#">157</a> | I2C Connection.....                      | <a href="#">174</a> |
| Automatic '-natural' values.....               | <a href="#">157</a> | Value ranges.....                        | <a href="#">174</a> |
| Automatic '-switch' calculation.....           | <a href="#">157</a> | Presets.....                             | <a href="#">174</a> |
| New playlist flags.....                        | <a href="#">158</a> | Algorithms (single mode).....            | <a href="#">175</a> |
| Loop markers in audio files.....               | <a href="#">158</a> | Algorithm-specific.....                  | <a href="#">176</a> |
| Wavetables.....                                | <a href="#">159</a> | MIDI / Select Bus.....                   | <a href="#">176</a> |
| Settings.....                                  | <a href="#">160</a> | Voice Control (for specified voice)..... | <a href="#">176</a> |
| General.....                                   | <a href="#">160</a> | Voice Control (note based).....          | <a href="#">177</a> |
| MIDI/I2C page 1.....                           | <a href="#">161</a> | Dual mode operations.....                | <a href="#">177</a> |
| MIDI/I2C page 2.....                           | <a href="#">162</a> | Other.....                               | <a href="#">178</a> |
| Favourites.....                                | <a href="#">163</a> | Calibration.....                         | <a href="#">179</a> |
| Calibration.....                               | <a href="#">163</a> | Firmware Updates.....                    | <a href="#">180</a> |
| Reset Settings.....                            | <a href="#">164</a> | Where to get help.....                   | <a href="#">180</a> |
| Miscellaneous functions.....                   | <a href="#">164</a> | Acknowledgments.....                     | <a href="#">181</a> |

## Introduction

Congratulations on your purchase of an Expert Sleepers 'super disting EX plus alpha' (hereafter 'disting EX'). Please read this user manual before operating your new module.

### ***A note on videos***

Throughout this user manual you will find links to videos, which illustrate the corresponding sections of the text. In general these have been shot at UHD (4k) resolution, which, as well as looking more awesome, has the practical benefit of making the module's display easier to read. You are advised to watch the videos in full resolution if possible.

### ***A note on navigating this manual***

When one part of the manual refers to another, it may say something like “see Menus, below”. In such cases the word 'below' (or 'above') is a hyperlink, and can be clicked on. Try it.

## Extra Content

In addition to the audio samples, wavetables, and presets on the MicroSD card supplied with the module, there is extra content to be had on our website, [here](https://expert-sleepers.co.uk/distingEXcontent.html)<sup>1</sup>.

---

<sup>1</sup> <https://expert-sleepers.co.uk/distingEXcontent.html>

## Installation

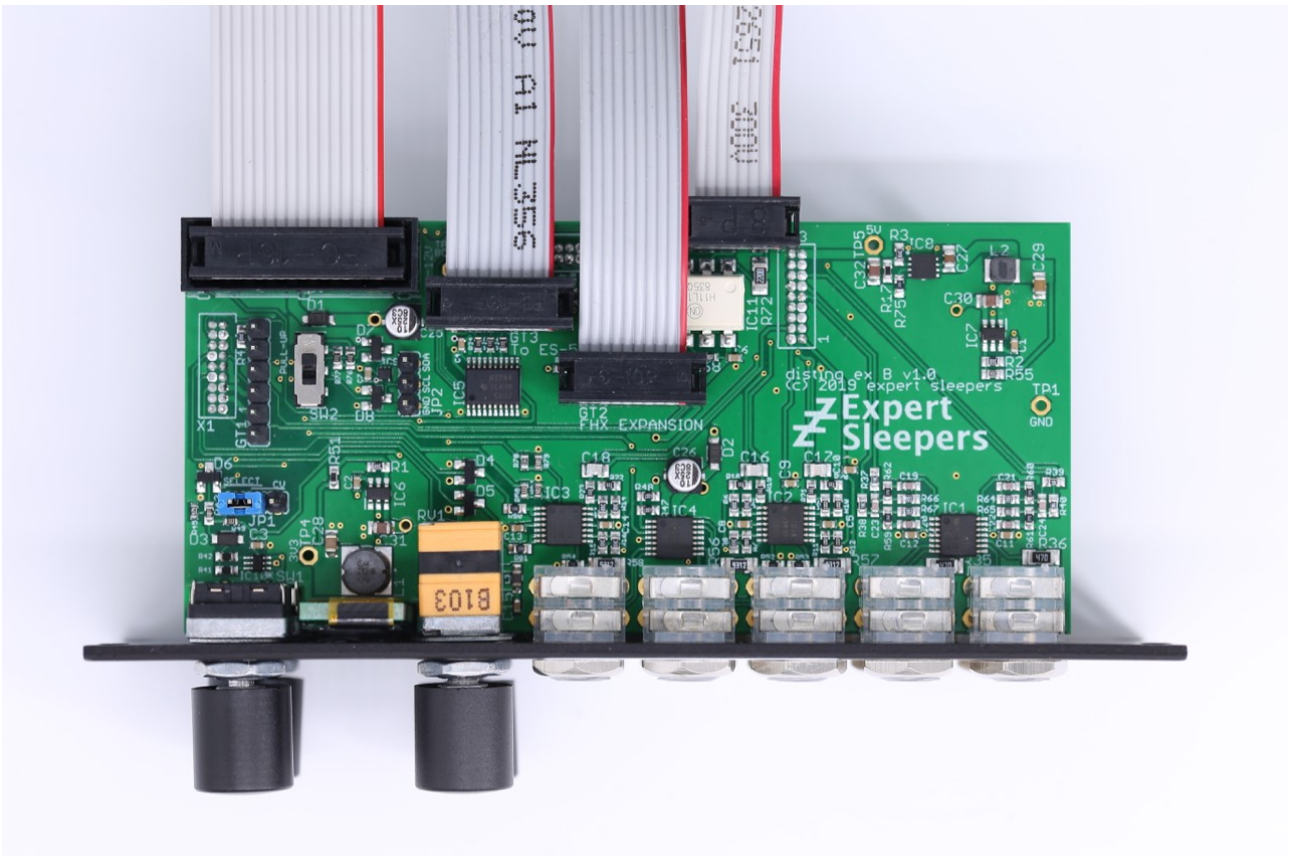

House the module in a Eurorack case of your choosing. The power connector is 16-pin [Doepfer standard](#)<sup>2</sup>. If using the power cable supplied with the module, the red edge of the cable is furthest from the top edge of the PCB, and carries -12V. ("-12V" is marked on the PCB itself next to this end of the connector.) Be sure to connect the other end of the power cable correctly, again so -12V corresponds to the red stripe on the cable.



### **Power requirements**

The disting EX draws up to 229mA on the +12V rail, and 50mA on the -12V rail.

It does not use the 5V rail.

### **Connecting expansion modules**

Turn off the power before connecting or disconnecting expansion modules.

<sup>2</sup> [http://www.doepfer.de/a100\\_man/a100t\\_e.htm](http://www.doepfer.de/a100_man/a100t_e.htm)



Connect an [ES-5](#)<sup>3</sup> module via the header on the back of the disting EX marked “GT3/To ES-5”, using the 10-way cable provided. The red stripe should be oriented down on both modules, as shown in the photo above, and in the [ES-5 user manual](#)<sup>4</sup>.

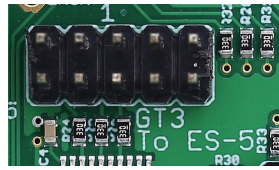

Connect an FHX-8GT or FHX-8CV module via the header on the back of the disting EX marked “GT2/FHX Expansion”. The red stripe should be oriented down on both modules, as shown in the photo above.

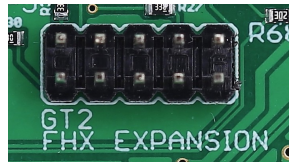

Connect a MIDI breakout to the header on the back of the disting EX marked “GT4/MIDI”. See the MIDI I/O section below.

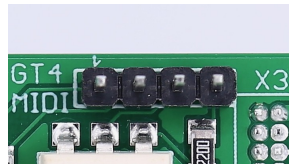

A device or module that communicates via I2C (e.g. the [16n Faderbank](#)<sup>5</sup>) can be connected via the header marked “JP2”. See the I2C Connection section below.

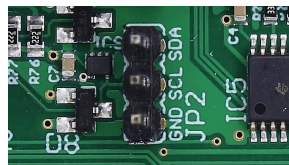

## Jumpers

There is one jumper header on the disting EX marked “JP1”, which sets whether the system CV bus line is used for pitch CV (the traditional use as implemented by Doepfer) or as the Select Bus. See below for more on the disting EX's Select Bus implementation.

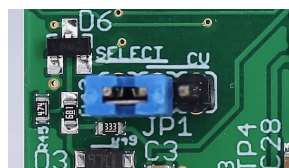

The photo above shows the jumper in the Select Bus position.

Regardless of this jumper position, the disting EX always connects to the system gate bus.

<sup>3</sup> <https://www.expert-sleepers.co.uk/es5.html>

<sup>4</sup> <https://expert-sleepers.co.uk/es5usermanual.html>

<sup>5</sup> <https://16n-faderbank.github.io>

## Inputs and Outputs



The disting EX has six analogue inputs and four analogue outputs on 3.5mm TS jack sockets. These are designed to cope with any Eurorack signal (with a range of approximately  $\pm 10V$ ), and are DC coupled, so can be used for CVs as well as audio.

The inputs are numbered on a white background; the four outputs are at the bottom of the module.

The disting mk4 labelling (Z/X/Y/A/B) is also printed on the panel, in orange.

The jack sockets are illuminated, lighting red for positive voltage and blue for negative voltage. (Audio appears purple, since it is a rapid alternation of positive and negative.)

## Controls

The disting EX has two rotary encoders (labelled P & V, notionally for 'parameter' and 'value') and two rotary potentiometers (labelled L & R, for 'left' and 'right'). All four of these controls also have a push-button function.

### ***A note on the pots***

On the disting mk4, the Z pot and the Z input jack are permanently linked, and the LEDs of the Z jack display the combined signal from the pot and jack.

On the disting EX, this is still the case when in dual mode, but in single mode the pots are completely independent of the jacks, and the jack LEDs reflect only the incoming signal.

## Menus



Many of the module's non-realtime functions are accessed via a menu. The menu is accessed by pressing 'P' (in single mode) or both 'P' & 'V' together (in dual mode).

While the menu is active, turning 'P' scrolls through menu items, and pressing 'P' chooses the current menu item (or descends to the next menu level, if the current menu item is a submenu). Pressing 'V' jumps back up one menu level. Holding down 'V' exits the menu completely.

## SD Card slot

The disting EX has a MicroSD card slot, to the left of the display.

### Inserting a MicroSD card

[Video](#) 

The exposed contacts of the card should face towards the display; the angled side of the card itself points up.

The slot is of the "push-push" type - to remove the card, push it in slightly and it will spring out.

### Supported MicroSD cards

In theory any MicroSD card will work, but in practice there is a huge variety of cards on the market and we cannot possibly test them all. We recommend 32GB SDHC cards.

The MicroSD card must be formatted in FAT32 format, which is the as-sold state for many cards. If not, cards can easily be reformatted to FAT32 in Windows or macOS.

An SD card formatting application is provided by the SD Association, which you can download [here](#)<sup>6</sup>. We recommend you use this instead of the formatting tools provided by the computer OS.

If you do use the OS's provided tools, the card also needs to be partitioned using the 'Master Boot Record' (MBR) scheme. In macOS's Disk Utility, you may need to select View->Show All Devices to inspect the partitioning scheme. The Erase settings should look like this:

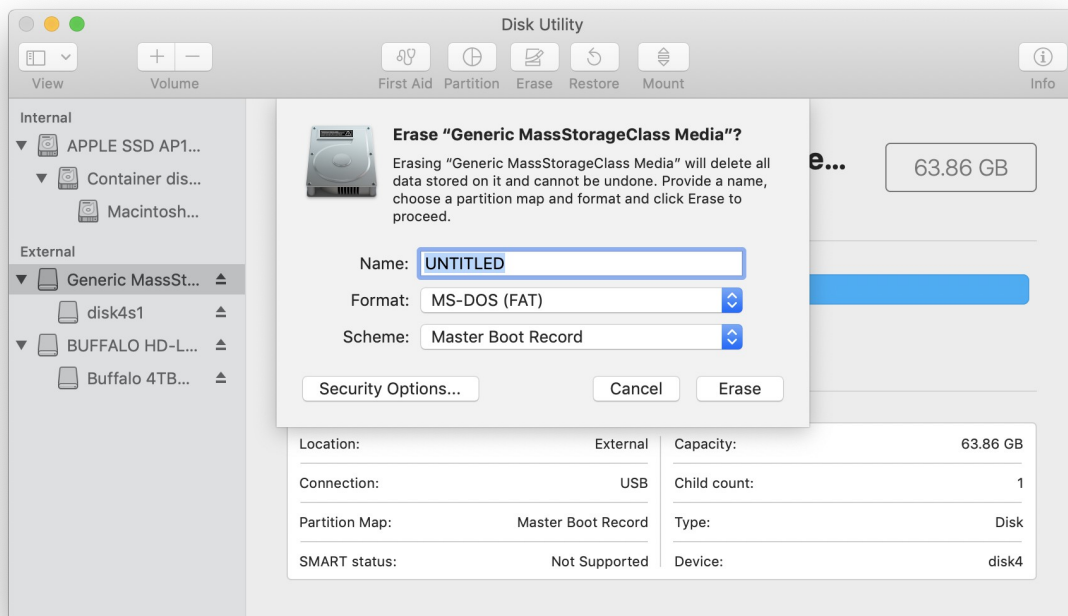

<sup>6</sup> <https://www.sdcard.org/downloads/formatter/>

The speed of your SD card can be estimated using the 'Test SD speed' menu (under Misc->Tests). The maximum speed achievable with the disting EX is around 3 MB/s.

Technical note: the disting EX accesses the MicroSD card in SPI mode, and so can never achieve the rated speed of the card, which assumes full SD bus access. It can however use High Speed mode where available to double the throughput. Unfortunately whether a given card supports High Speed mode over SPI seems to be hard to gauge from the specs – we've tested a number of cards rated at UHS-I and above, some of which support High Speed mode and some of which don't. For the record, the Samsung EVO range do; the Sandisk Extreme range does not. A card which does not support High Speed mode will read around 1.8 MB/s on the disting EX's 'Test SD speed'.

A card that reads less than around 1.8 MB/s should be viewed with suspicion, and is probably not a good choice for card-intensive purposes such as playing or recording WAV files.

There is a setting (see below) to enable or disable the use of High Speed mode.

The card provided with the module will work for firmware updates and non-realtime use (for example, loading wavetables). It is not guaranteed to work flawlessly for streaming audio files (for example, when using the SD Multisample algorithm) – there's just no card on the market that we can source which is specified that way.

## Overview

The disting EX is a multifunction module. Its various functions are referred to as **algorithms**. Types of algorithms include

- audio processing (audio in, audio out e.g. delays, reverbs)
- CV processing (CV in, CV out e.g. quantisers)
- CV generation (e.g. envelopes)
- audio generation (e.g. VCOs, WAV playback)

The disting EX builds on the rich legacy of the disting mk4, and can be used essentially as two disting mk4s with a shared display. This is known as **dual mode** as is described in more detail below.

The disting EX also includes its own unique algorithms, which take over the whole module in what we call **single mode**.

Because the disting mk4 has relatively few CV inputs, and because its small display makes accessing a large number of parameters awkward, it tends towards a proliferation of algorithms which are similar to one another but have, say, different means of CV control. In contrast the disting EX's single mode algorithms tend to be fewer but much more configurable.

## Single Mode

### Single mode concepts

[Video](#) 

The disting EX runs one single mode algorithm at a time. Switching algorithms is done via the Algorithms menu (see above for basic information on using the menus).

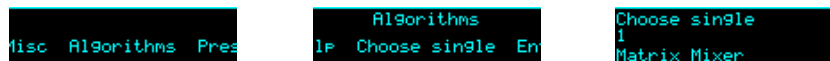

The image shows three sequential screenshots of the disting EX display. The first shows the 'Algorithms' menu with 'Choose single' highlighted. The second shows the 'Choose single' menu with 'Matrix Mixer' highlighted. The third shows the 'Matrix Mixer' algorithm's parameter display.

There are two fundamental elements that define a single algorithm's operation, the **preset** and the **mapping**.

The **preset** is the state of the algorithm's parameters – a set of numerical values that control how the algorithm works. For example, the delay time of a delay effect, or the choice of samples files in a WAV playback algorithm.

The **mapping** defines how the parameters are controlled by a number of control sources – primarily, the module's own CV inputs, but also MIDI, I2C etc.

Changing algorithm resets the current preset and mappings to defaults.

### Single mode display & controls

The display in single mode often varies with each algorithm, but is based around the common structure show below:

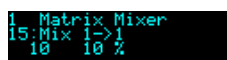

The image shows a screenshot of the disting EX display for the 'Matrix Mixer' algorithm. The first line shows '1 Matrix Mixer'. The second line shows '15: Mix 1 -> 1'. The third line shows '10 10 %'.

The first line simply shows the algorithm number and name.

The second line shows the current parameter number and name. Turning the 'P' knob scrolls through the parameters.

### Video

The third line shows the current parameter's value, and if appropriate, its unit (the unit in the screenshot above is "%"). You'll note that there are two values shown. The first (leftmost) is the parameter's **base value**. This is the one set by the preset, and is the one you edit when you turn the 'V' knob. The second value is the parameter's **effective value**. This is the value after control by CV inputs etc. has been taken into account, and is the actual value being used by the algorithm.

If a parameter is not under CV control, these two values will always be the same. When CV control is applied, this offsets the base value by an amount related to the CV.

If the 'R' knob has not been set up in the mapping, it defaults to changing the current parameter. Since 'R' is an absolute positional control (a pot, not an encoder) this can make it much easier to dial in values quickly, especially if the parameter has a large range.

Note that 'V' and 'R' are adjusting the same value, just in different ways.

If the 'R' button has not been set up in the mapping, it defaults to setting the current parameter to its default value when pushed.

Holding 'V' shows a key of the current input and knob functions, either as hardwired into the algorithm or set by the mapping.



Turning 'V' while held changes the key to show the outputs.



If the module has an active MIDI connection, the top right of the display shows MIDI in & out activity indicators:



When a preset is loaded (or saved), the top line shows the preset number and name instead of the algorithm name:

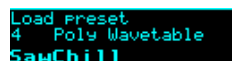

As soon as the preset is edited, the display reverts to the algorithm name:



## Parameters with confirm

Some parameter changes do not take effect immediately, but wait for user confirmation. Typically these are things which take a while, such as choosing a wavetable in the Poly Wavetable algorithm.



When these parameter are changed, "PUSH V" appears in the display. Pushing the 'V' encoder confirms the new parameter value.

## Display zoom



If enabled in the Settings (see below), the current parameter name or value is temporarily shown in a larger font.

```
11:Release  
time
```

```
77 77  
1282ms
```

```
3: SD Multisample  
11:Release time 1282ms  
77 77
```

The value in the Settings is a multiple of 100ms for which to show the zoomed version. For example, a value of 10 shows the zoomed version for 1 second.

## Single mode common parameters

Every algorithm in single mode shares a number of parameters. These are:

|   | Name           | Min  | Max | Default | Unit | Description   |
|---|----------------|------|-----|---------|------|---|
| 1 | Attenuverter 1 | -200 | 200 | 100     | %    | Applies an attenuverter <sup>7</sup> to input 1. A negative value indicates that the CV will be inverted. |
| 2 | Attenuverter 2 | -200 | 200 | 100     | %    | As above for input 2.   |
| 3 | Attenuverter 3 | -200 | 200 | 100     | %    | As above for input 3.   |
| 4 | Attenuverter 4 | -200 | 200 | 100     | %    | As above for input 4.   |
| 5 | Attenuverter 5 | -200 | 200 | 100     | %    | As above for input 5.   |
| 6 | Attenuverter 6 | -200 | 200 | 100     | %    | As above for input 6.   |

The attenuverters affect the incoming audio/CV signal just like an attenuator knob on an analogue module. Anything that uses the signal downstream (including parameter automation) uses the attenuated signal.

## Single mode help



```
Algorithms  
al mode Help Choose
```

```
Augustus Loop is a  
distinct EX  
implementation of one  
of Expert Sleepers'
```

```
delay signal only.  
time (coarse)  
Sets the delay time,  
in multiples of
```

Each algorithm's user manual section can be accessed via the Algorithms menu.

The help display can be scrolled with 'P', 'V', or (rapidly) with 'R'.

<sup>7</sup> An attenuverter is a Eurorack term for a combination of an attenuator and an inverter. These aren't strictly attenuators because the gain goes above 100%.

## Dual Mode

In dual mode, the disting EX essentially behaves like two souped-up [disting mk4s](#)<sup>8</sup>.

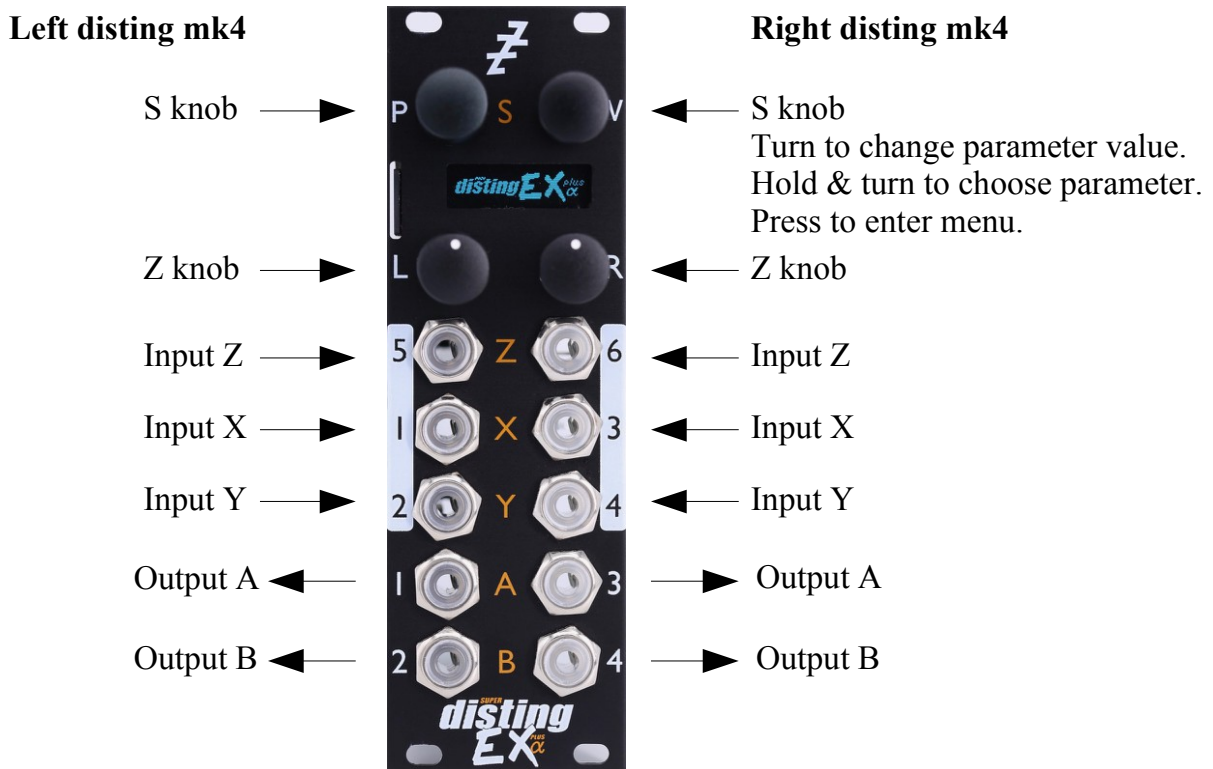

We do not propose to reproduce the entire disting mk4 [user manual](#)<sup>9</sup> here, which is itself a 125 page document. Instead, below is a list of ways in which the disting EX in dual mode differs from a disting mk4.

### ***disting mk4 firmware version***

This version of the disting EX firmware is synchronised with version 4.24 of the disting mk4 firmware. Please refer to that version of the disting mk4 user manual.

### ***Sample rate***

The disting mk4 runs at 75kHz in general, with some algorithms running lower for performance reasons. The disting EX runs at 96kHz.

### ***Scala support***

The 'logTables\_16\_20.bin' file is not required.

### ***Favourites***

Whereas on a disting mk4 these are set up with a text file on the MicroSD card, on the disting EX they are set via the Settings menu (see below).

<sup>8</sup> <https://www.expert-sleepers.co.uk/disting.html>

<sup>9</sup> <https://www.expert-sleepers.co.uk/distingfirmwareupdates.html>



## Help

[Video](#) 

[Video](#) 

The per-algorithm help is hardcoded into the firmware – it is not stored on the SD card. Also it displays the help a page at a time, rather than scrolling it a character at a time!

```
Output A is the sum
of inputs X & Y;
Output B is the
difference between
```

The algorithm help can be accessed via the dual mode menu, as shown in the first video above. It can also be quickly accessed by holding down the encoder for more than one second (shown in the second video), in which case it will be dismissed when the encoder is released. Note that you can still scroll through the help by turning the encoder, whichever way you access it.

The first screen's worth of help for each algorithm is an overview of the inputs and outputs:

```
X: input  Z: offset
Y: input
A: X + Y + offset
B: X - Y - offset
```

## Z push functions & the Knob Recorder

On the disting mk4, the effect of pushing the Z knob is very algorithm-dependent – by default it advances to the next parameter, but an algorithm may override it to perform some other function e.g. 'freeze' on the reverbs, or the knob recorder.

The disting EX lets you choose this behaviour, via the dual-mode menu Options->Z function. The options are:

|                   |   |
|-------------------|---|
| Function or Param | As on the disting mk4, pressing Z advances to the next parameter, unless the algorithm defines another function for it. |
| Function          | Pressing Z always performs the algorithm-specific function, if any.   |
| Parameter         | Pressing Z always advances to the next parameter.   |
| Knob Recorder     | Pressing Z is used to activate the knob recorder.   |

This choice is stored as part of a preset.

Note that this means you have the option of using the knob recorder with any algorithm, not just those for which the disting mk4 implements it.

When the knob recorder is chosen, holding Z down while turning it causes the Z value changes to be recorded. As soon as the knob is released, the recording is played back in a loop. To end playback, turn the Z knob slightly to regain manual control.

## disting mk4 algorithms not included

The following disting mk4 algorithms are not included in the disting EX:

- J-5 Audio Recorder & J-7 Mono Audio Recorder
  - You can use the disting EX's WAV Recorder mode instead.
- K-6 Clockable SD Delay, K-7 Stereo Clockable SD Delay, K-8 Stereo Clockable SD Delay (Z clock) & N-8 Clockable SD Ping Pong
  - On the disting EX, the equivalent non-SD versions have much longer delay times.

## ***disting mk4 algorithms with improved specifications***

- B-4 Clockable Delay/Echo
  - Operates at 96kHz and offers a maximum delay time of around 22 seconds.
- C-3 Clockable Ping Pong Delay (Z feedback) & C-4 Clockable Ping Pong Delay (Z input pan)
  - Operate at 96kHz and offer a maximum delay time of around 11 seconds.
- C-8 Bit Crusher
  - Has an option for stereo operation.
- D-2 Tape Delay & M-6 Stereo Tape Delay
  - Maximum delay time is around 11 seconds (mono)/5.5 seconds (stereo). The algorithms have an extra 'Coarse' parameter to access the extra delay time available.
- G-7 MIDI/CV
  - Supports MTS (MIDI Tuning Standard) – see below.
- H-2 Dual Sample and Hold
  - Has extra features which essentially turn it into a whole new algorithm, which is documented in full below.
- K-1 Wavetable VCO, K-2 Clockable Wavetable LFO, K-3 Wavetable Waveshaper, K-4 Clockable Wavetable Envelope & N-5 Pulsar VCO
  - These algorithms support up to 1000 files in a wavetable folder, and up to 2 million total wave samples (100/29000 on the disting mk4).
- All Audio Playback algorithms
  - 24 bit WAV files are supported.
  - Triggering latency is down from 3ms to 700µs.
  - Enhanced support for embedded loop information (see below).
- Both MIDI File Playback algorithms
  - Have an extra parameter, 'MIDI out channel'. If set to '-1', the MIDI channels in the file are used (as on the mk4). If set to '0', no MIDI is output. Otherwise the MIDI in the file is forced to use the set MIDI channel number.
- K-5 Programmable Quantizer
  - Supports MTS (MIDI Tuning Standard) – see below.
- L-1 Stereo Reverb, L-2 Mono-to-Stereo Reverb & L-3 Dual Reverb
  - The maximum reverb size parameter is 99 (rather than 32).
  - Changes in reverb size are smooth, without audio glitches.
- M-7 Granular Pitch Shifter
  - The maximum delay parameter is 99 (rather than 32).

- N-7 Frequency Shifter
  - Has extra features which essentially turn it into a whole new algorithm, which is documented in full below.

## **Extra algorithms not part of the disting mk4**

While most of the dual mode algorithms are from the disting mk4, there are some extra algorithms which do not exist on the mk4. These are documented below.

## **Entering dual mode**

[Video](#) 

From the menu, choose 'Algorithms', then 'Enter dual mode'.

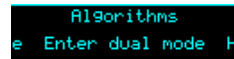
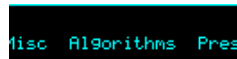

## **Accessing the main menu from dual mode**

In dual mode, the two encoders enter the disting mk4-style menus of their respective halves. To access the main menu, press both encoders at the same time.

## **Presets in dual mode**

Each half can save and load presets, as on the disting mk4, though there are more (256) slots available.

Also, from the main menu you can save & load a 'dual preset', which stores the parameters for both halves, and can be named. See Presets, below.

## **Dual display modes**

[Video](#) 

The default display mode in dual mode presents the two halves side by side:



When a parameter is changed, or a menu is used, the display zooms to use the whole screen for the half being edited. A bar is drawn at the top of the screen showing whether the left or right half is being accessed:

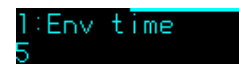
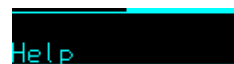
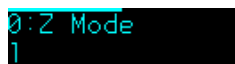

The images above show a menu and a parameter being accessed for the left & right halves respectively.

In the main Settings menu (see below) you can choose alternative dual display modes. The options are 'Standard', 'Standard (no zoom)' and 'Retro'. The 'no zoom' option is as above but the display never zooms to use the entire screen for one half. The 'Retro' option recreates the actual disting mk4 display – a 5x7 LED matrix for each half:



# Presets

A preset on the disting EX stores the following information:

- The preset name.
- The current algorithm(s).
- The algorithm parameters.
- The mapping to load when the preset is loaded.
- The current parameter.
- For dual algorithms:
  - The chosen Z function.
  - Whether the Z knob was overridden by MIDI (and if so, the MIDI value).
- For single algorithms:
  - Any folder and/or file names used by the algorithm.

Presets can be stored in the module's flash memory and/or on the MicroSD card. There are 256 preset slots in flash memory. You can also save all 256 presets to/from MicroSD at once.

All preset functions are accessed via the top-level Presets menu.



## Web-based preset editor

There is an 'early access' (i.e. not very polished but usable) GUI preset editor for the disting EX [here](#)<sup>10</sup>. It connects to the module via MIDI.

Refresh
Send to MIDI port: 
Listen on MIDI port:

```
15:00:38: received sysex (35 bytes)
15:00:38: sent parameter info request to disting EX
15:00:38: received sysex (34 bytes)
15:00:38: sent parameter info request to disting EX
15:00:38: received sysex (29 bytes)
```

```
15:00:38
F0 00 21 27 5D 43 47 F7
```

```
15:00:38
F0 00 21 27 5D 4
00 4D 61 78 20 7
```

Auto-focus:

Algorithm: 10 - Poly Wavetable

Preset name:

|    | Name           | Min  | Max | Default | Unit      | Value                            | Control                           |
|----|----------------|------|-----|---------|-----------|----------------------------------|-----------------------------------|
| 1  | Attenuverter 1 | -200 | 200 | 100     | %         | <input type="text" value="100"/> | <input type="range" value="100"/> |
| 2  | Attenuverter 2 | -200 | 200 | 100     | %         | <input type="text" value="100"/> | <input type="range" value="100"/> |
| 3  | Attenuverter 3 | -200 | 200 | 100     | %         | <input type="text" value="100"/> | <input type="range" value="100"/> |
| 4  | Attenuverter 4 | -200 | 200 | 100     | %         | <input type="text" value="100"/> | <input type="range" value="100"/> |
| 5  | Attenuverter 5 | -200 | 200 | 100     | %         | <input type="text" value="100"/> | <input type="range" value="100"/> |
| 6  | Attenuverter 6 | -200 | 200 | 100     | %         | <input type="text" value="100"/> | <input type="range" value="100"/> |
| 7  | Wavetable      | 0    | 12  | 0       |           | <input type="text" value="0"/>   | <input type="range" value="0"/>   |
| 8  | Wave offset    | -100 | 100 | 0       |           | <input type="text" value="0"/>   | <input type="range" value="0"/>   |
| 9  | Wave spread    | -100 | 100 | 0       |           | <input type="text" value="0"/>   | <input type="range" value="0"/>   |
| 10 | Coarse tune    | -60  | 60  | 0       | semitones | <input type="text" value="0"/>   | <input type="range" value="0"/>   |

<sup>10</sup> [https://github.com/expertsleepersltd/distingEX\\_tools](https://github.com/expertsleepersltd/distingEX_tools)

Users have also created editors in MIDI controller apps – for example, see [here](#)<sup>11</sup> for some nice [TouchOSC](#)<sup>12</sup> layouts.

## Load preset

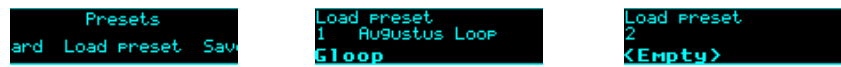

Loads a preset from flash memory. Use the 'P' knob to choose the preset slot. The preset name is shown at the bottom of the screen, or <Empty> if the slot is empty. The preset algorithm is also displayed.

Optionally, the 'L' and 'R' buttons can be set to step through the presets for the current algorithm. This is enabled in the Settings (see below).

## Save preset

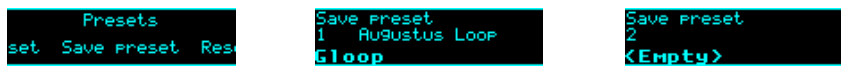

Saves the current module state to a preset in flash memory. Use the 'P' knob to choose the preset slot. If the slot is not empty, the preset name and algorithm are shown.

## Reset preset

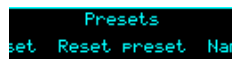

Resets the current state to defaults (for the current algorithm).

## Name preset



Allows you to edit the name of the current preset. Typically you would do this before saving it.

Use the 'P' knob to move the cursor, and the 'V' or 'R' knobs to edit the character under the cursor.

## Erase preset

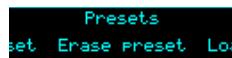

Allows you to erase a preset slot in flash memory, reverting it to 'empty'.

## Load from SD card

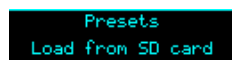

Loads a preset from the MicroSD card.

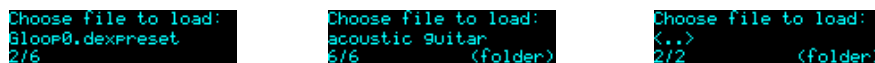

Use the 'P' knob to choose the preset file to load.

<sup>11</sup> <https://modwiggler.com/forum/viewtopic.php?t=257083>

<sup>12</sup> <https://hexler.net/products/touchosc>

Preset files may be located at the top level of the card, or inside folders. If a folder contains preset files, it is included in the names you can choose with 'P', and "(folder)" is displayed. Pressing 'P' will enter the folder and let you browse the preset files therein. Choosing the special item <.> steps back up to the parent folder.

## Save to SD card



```
Presets
d Save to SD card L
```

```
Saved to
Fool.dexpreset
```

Saves the current module state to a preset file on the SD card. The file is placed in the root folder, and the filename is automatically constructed from the preset name.

## Bulk operations

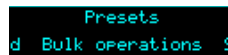

```
Presets
d Bulk operations S
```

The “Bulk operations” submenu contains functions which operate on many (or all) presets at once.

## Load all from SD card

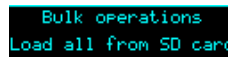

```
Bulk operations
Load all from SD card
```

Loads an 'all presets' file from the MicroSD card.

Take care – this function replaces all the presets saved in flash memory with those loaded from the card.

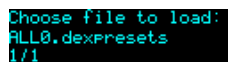

```
Choose file to load:
ALL0.dexpresets
1/1
```

Use the 'P' knob to choose the preset file to load.

## Save all to SD card



```
Bulk operations
Save all to SD card
```

```
Saved to
ALL1.dexpresets
```

Saves all the presets in flash memory to a file on the MicroSD card. The file is placed in the root folder, and is named 'ALL<n>.dexpresets' where <n> is a number which increments to make the filename unique.

## Load from folder to

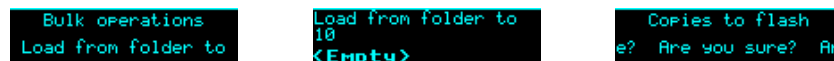

```
Bulk operations
Load from folder to
```

```
Load from folder to
10
<Empty>
```

```
Copies to flash
e? Are you sure? Ar
```

Loads all the presets from a folder on the MicroSD card and installs them into flash memory, starting at the selected slot.

## Save all to folder



```
Bulk operations
Save all to folder
```

```
Saved to
PRST0003
```

Saves all the presets from flash which are not empty as individual preset files to a folder on the MicroSD card. A new folder is created named 'PRST<n>' where <n> is a number which increments

to make the folder name unique.

## **Load all dual from SD**

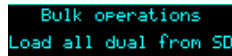

```
Bulk operations
Load all dual from SD
```

Loads an 'all dual presets' file from the MicroSD card.

Take care – this function replaces all the dual mode presets saved in flash memory with those loaded from the card.

## **Save all dual to SD**

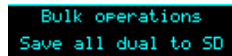

```
Bulk operations
Save all dual to SD
```



```
Saved to
ALL2.dexduals
```

Saves all the dual mode presets in flash memory to a file on the MicroSD card. The file is placed in the root folder, and is named 'ALL<n>.dexduals' where <n> is a number which increments to make the filename unique.

## **Set preset mapping**

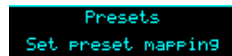

```
Presets
Set preset mapping
```

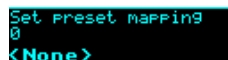

```
Set preset mapping
0
<None>
```

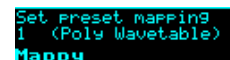

```
Set preset mapping
1 (Poly Wavetable)
Mappy
```

Sets the mapping to load automatically when the preset is loaded, or 0 for 'None'.

## **Auto-save**

If enabled in the Settings (see below) the module will periodically save its current state, and reload it when the module next powers up.

When an automatic save is performed, the message “\*AUTO-SAVE\*” will flash up on the display.

Auto-saves do not use one of the regular preset slots. If you want to save a preset that you can reload at will, use one of the manual save mechanisms.

An auto-save happens 10 seconds after any change (this delay is to ensure the module is not constantly auto-saving while you're changing values), except that auto-saving is prevented while audio is being played from or recorded to the SD card (this is largely precautionary – SD usage can be performance critical).

You can prevent the module loading its startup or auto-saved preset by holding the 'P' encoder down during the 'disting EX' splash screen (after the bootloader screen).

## Mappings

A 'mapping' stores all the information about how an algorithm's parameters are controlled by CV, MIDI etc. It is dealt with separately from a preset on the rationale that you will change a mapping less often than a preset.

Most of the Mappings functionality applies to single mode algorithms only, except for MIDI mappings, which also apply to dual mode.

Mappings can be stored in the module's flash memory and/or on the MicroSD card. There are 64 mapping slots in flash memory. You can also save all 64 mappings to/from MicroSD at once.

All mapping functions are accessed via the top-level Mappings menu.

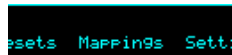

All parameters of an algorithm can be mapped to MIDI and I2C. Only the first 64 parameters can be mapped to CVs, knobs, and buttons.

### Web-based editor

There is an 'early access' (i.e. not very polished but usable) GUI preset editor for the disting EX [here](#)<sup>13</sup>, which also allows for viewing/editing of mappings. It connects to the module via MIDI.

### CV Mappings

[Video](#) 

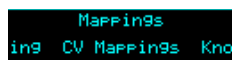

CV mappings let you control algorithm parameters from the module's six CV inputs. Every parameter can be assigned to a CV input simultaneously, and each parameter's response to that CV set independently.

The CV mappings offset the values set manually – the parameter value calculated from the CV voltage is added to the value set via the parameter/value knobs.

When you switch to a new algorithm, some CV mappings may be set up by default. Even for parameters which do not by default have an active CV mapping, the CV scalings are set appropriately so that simply enabling a CV input will control the parameter in a sensible way, usually mapping the range  $\pm 5V$  to the whole parameter range.



On the mapping editing screen, move the cursor (the dotted rectangle) with the 'P' knob. Turn the 'V' or 'R' knobs to adjust the value under the cursor. There are five cursor positions:

- The parameter number – choose which parameter's mapping you want to edit.
- The input – choose the CV input to use, or “-” for none.
- The CV polarity – choose “Bipolar” to use both positive and negative CV voltages, or “Unipolar” to use only positive voltages.
- Whether to treat the CV as a gate – choose “Norm” for a normal CV, or “Gate” for a gate. A

<sup>13</sup> [https://github.com/expertsleepersltd/distingEX\\_tools](https://github.com/expertsleepersltd/distingEX_tools)



gate-type mapping switches between the parameter's minimum and maximum when the input goes over 1V.

- The CV scaling – the relationship between incoming voltages and the parameter values. For example, in the screenshot above, Input 4 is controlling the Input Level with a scaling of 20.0%/V – that is, it will take a CV of 5V to change the input level by 100%.

## Knob Mappings

[Video](#) 

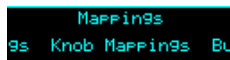

Knob mappings let you control algorithm parameters from the module's 'L' & 'R' knobs. Every parameter can be assigned to a knob simultaneously, and each parameter's response to that knob set independently.

The knob mappings can either offset the values set manually – the parameter value calculated from the knob is added to the value previously set – or they can directly set the parameter value.

When you switch to a new algorithm, some knob mappings may be set up by default. Even for parameters which do not by default have an active knob mapping, the knob scalings are set appropriately so that simply enabling a knob will control the parameter in a sensible way, usually mapping the knob to the whole parameter range.

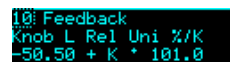

On the mapping editing screen, move the cursor (the dotted rectangle) with the 'P' knob. Turn the 'V' or 'R' knobs to adjust the value under the cursor. There are six cursor positions:

- The parameter number – choose which parameter's mapping you want to edit.
- The knob – choose the knob to use, or “-” for none.
- Whether the knob offsets the parameter value (“Rel” or relative mode) or sets it directly (“Abs” or absolute mode).
- Whether the knob is considered Unipolar (range 0-1) or Bipolar (range  $\pm 1$ ). This simply makes it easier to set the scale and offset values below.
- The knob offset, and
- The knob scale. These two values let you define the relationship between the knob position and the value set by the mapping. The value is  $\text{Offset} + K * \text{Scale}$ , where K is a value in the range [0,1] or [-1,1] (depending on the Uni/Bi setting).

## Button Mappings

[Video](#) 

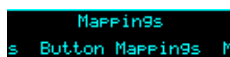

Button mappings let you control algorithm parameters from pushing the module's 'L' & 'R' knobs. Every parameter can be assigned to a button simultaneously, and each parameter's response to that button set independently.

The button mappings offset the values set manually – the parameter value from the button is added to the value set via the parameter/value knobs.

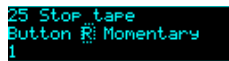

On the mapping editing screen, move the cursor (the dotted rectangle) with the 'P' knob. Turn the 'V' or 'R' knobs to adjust the value under the cursor. There are four cursor positions:

- The parameter number – choose which parameter's mapping you want to edit.
- The button – choose the button to use, or “-” for none.
- The behaviour – choose “momentary” or “latching”.
- The offset – the value to be added to the parameter when you press the button.

## MIDI Mappings

[Video](#) 

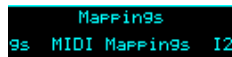

MIDI mappings let you control algorithm parameters via MIDI continuous controllers (CCs) and certain other MIDI messages. Every parameter can be assigned to a CC simultaneously, and each parameter's response to that CC set independently.

MIDI mappings can be used to control the module from MIDI devices or MIDI controller software. For example, see [here](#)<sup>14</sup> for some nice [TouchOSC](#)<sup>15</sup> layouts.

The MIDI mappings set the base parameter values, exactly as if you had changed the value manually with the 'V' knob.

When you switch to a new algorithm, default MIDI mappings are applied.

In single mode, default mappings control parameters 7 and up (i.e. everything except the common attenuverter parameters) from MIDI CCs 7 and up<sup>16</sup>. The CC value range of 0-127 is mapped to the parameter's full value range.

In dual mode, default mappings recreate the (fixed) disting mk4 MIDI CC control, which maps CCs 1-8 to parameters 0-7, and CCs 17-19 to “Set Z”, “Select algorithm”, and “Free Z” respectively.



On the mapping editing screen, move the cursor (the dotted rectangle) with the 'P' knob. Turn the 'V' or 'R' knobs to adjust the value under the cursor. There are six cursor positions:

- The parameter number – choose which parameter's mapping you want to edit.
- The CC number – choose which MIDI CC you want to control the parameter, or 'After' to choose aftertouch (aka channel pressure).
- The Enabled/Disabled setting.
- Whether the CC is treated as normal (“Norm”) or symmetric (“Sym”). For a normal CC, the range 0-127 is mapped across the range set by the min & max settings below. For a symmetric CC, the value 64 is mapped to the mid point of the range, and values above and

14 <https://modwiggler.com/forum/viewtopic.php?t=257083>

15 <https://hexler.net/products/touchosc>

16 This CC number can be changed in the Settings.

below that are scaled by half the total range. A symmetric mapping is appropriate for a parameter which has a bipolar range around zero (for example, a pan position), where you want to be sure that a MIDI value of 64 gives you exactly zero in the middle.

- The minimum (“Min”) and
- the maximum (“Max”) parameter values for the mapping.

While editing the MIDI mapping, pressing 'P' enters 'MIDI learn' mode.

A rectangular button with the word "LEARN" in a bright cyan, monospace-style font. The button has a black background and a thin cyan border.

The first CC received by the module after activating Learn will be assigned to the current mapping.

There is a setting for whether a mapping set by Learn automatically unsets any other mapping that uses the same CC. See below.

Press 'P' again to cancel Learn.

The module can also use the MIDI mappings in reverse to send parameter changes back to the controlling device/software. This is enabled via the 'Send CCs' setting (below). The options are 'Off', 'On preset load', 'On parameter change', or 'Both'.

## I2C Mappings

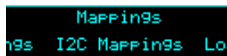
A menu screen with a black background and cyan text. The word "MAPPINGS" is centered at the top. Below it, the text "I2C Mappings" is visible, followed by a partially visible "Lo" on the right.

I2C mappings let you control algorithm parameters via the I2C bus (see below). Every parameter can be assigned an I2C controller simultaneously, and each parameter's response to that controller set independently.

The I2C mappings set the base parameter values, exactly as if you had changed the value manually with the 'V' knob.

When you switch to a new algorithm, default I2C mappings are applied, which is to control parameters 7 and up (i.e. everything except the common attenuverter parameters) from I2C controllers 0 and up. The controller range of 0-16383 is mapped to the parameter's full value range.

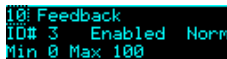
A small screen showing mapping details for "I2C Feedback". The text is cyan on a black background. It shows "ID# 3", "Enabled", "Norm", "Min 0", and "Max 100".

On the mapping editing screen, move the cursor (the dotted rectangle) with the 'P' knob. Turn the 'V' or 'R' knobs to adjust the value under the cursor. There are six cursor positions:

- The parameter number – choose which parameter's mapping you want to edit.
- The controller number – choose which I2C controller you want to control the parameter.
- The Enabled/Disabled setting.
- Whether the CC is treated as normal (“Norm”) or symmetric (“Sym”). For a normal CC, the range 0- 16383 is mapped across the range set by the min & max settings below. For a symmetric CC, the value 8192 is mapped to the mid point of the range, and values above and below that are scaled by half the total range. A symmetric mapping is appropriate for a parameter which has a bipolar range around zero (for example, a pan position), where you want to be sure that a controller value of 8192 gives you exactly zero in the middle.
- The minimum (“Min”) and
- the maximum (“Max”) parameter values for the mapping.

While editing the I2C mapping, pressing 'P' enters 'I2C learn' mode.



The first I2C controller received by the module after activating Learn will be assigned to the current mapping.

There is a setting for whether a mapping set by Learn automatically unsets any other mapping that uses the same controller. See below.

Press 'P' again to cancel Learn.

### Load mapping

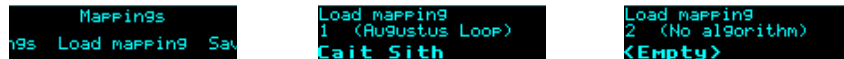

Loads a mapping from flash memory. Use the 'P' knob to choose the mapping slot. The mapping name is shown at the bottom of the screen, or <Empty> if the slot is empty. The algorithm for which the mapping was saved is also displayed.

### Save mapping



Saves the current module mapping state to a mapping in flash memory. Use the 'P' knob to choose the mapping slot. If the slot is not empty, the mapping name and algorithm are shown.

### Reset mapping

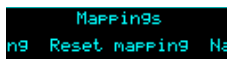

Resets the current mapping to defaults (for the current algorithm).

### Name mapping



Allows you to edit the name of the current mapping. Typically you would do this before saving it. Use the 'P' knob to move the cursor, and the 'V' or 'R' knobs to edit the character under the cursor.

### Load from SD card

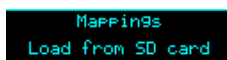

Loads a mapping from the MicroSD card.

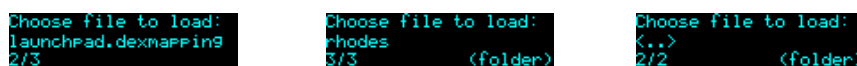

Use the 'P' knob to choose the mapping file to load.

Mapping files may be located at the top level of the card, or inside folders. If a folder contains mapping files, it is included in the names you can choose with 'P', and "(folder)" is displayed. Pressing 'P' will enter the folder and let you browse the mapping files therein. Choosing the special

item <.> steps back up to the parent folder.

### **Save to SD card**



Saves the current mapping to a file on the SD card. The file is placed in the root folder, and the filename is automatically constructed from the mapping name.

### **Load all from SD card**

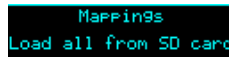

Loads an 'all mappings' file from the MicroSD card.

Take care – this function replaces all the mappings saved in flash memory with those loaded from the card.

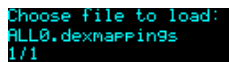

Use the 'P' knob to choose the mapping file to load.

### **Save all to SD card**



Saves all the mappings in flash memory to a file on the MicroSD card. The file is placed in the root folder, and is named 'ALL<n>.dexmappings' where <n> is a number which increments to make the filename unique.

## **Single Mode Algorithms**

The following pages describe the disting EX's “single mode” algorithms.

# 1 – Matrix Mixer

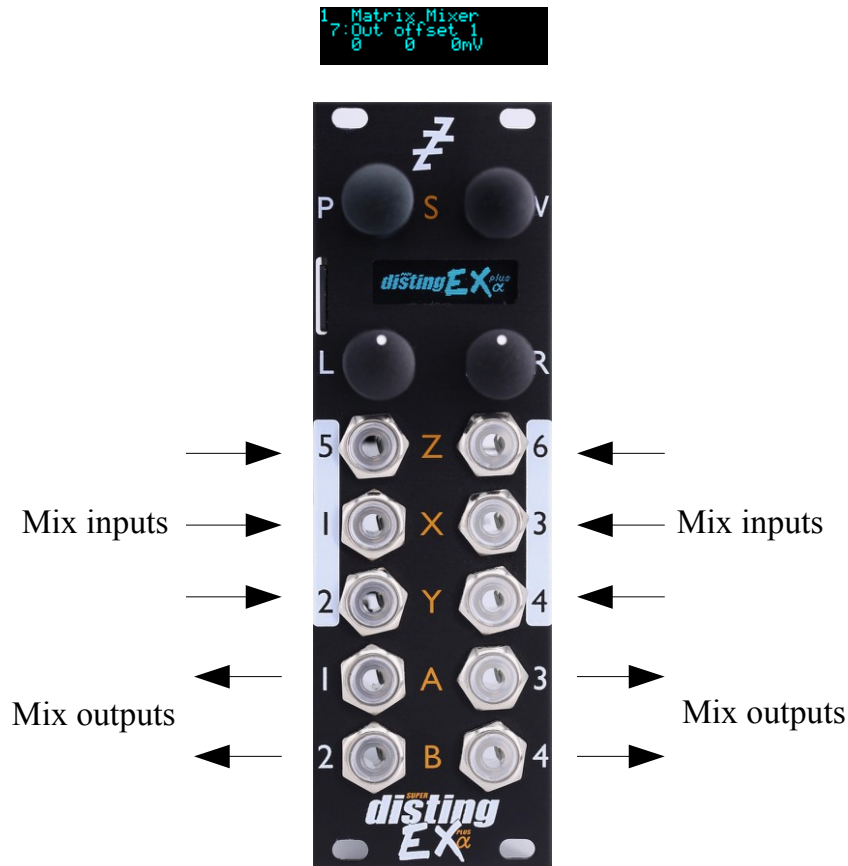

The Matrix Mixer is a flexible 6 into 4 mixer, mainly designed for CV processing, though it will happily handle audio as well. As well as a static mix, the algorithm is capable of complex dynamic mixes when CV mapping is used, and also of CV generation – for example, by automating the input and output offsets to generate four CVs which might control the rest of your patch in a 'macro' fashion.

## Parameters

|       | Name                | Min    | Max   | Default | Unit | Description  |
|-------|---------------------|--------|-------|---------|------|--|
| 1-6   | Attenuverter 1-6    | -200   | 200   | 100     | %    | Applies an attenuverter to the corresponding input. A negative value indicates that the CV will be inverted.   |
| 7-10  | Out offset 1-4      | -10000 | 10000 | 0       |      | Output offset for outputs 1-4. The unit of the offset depends on the corresponding 'Out offset type' parameter. The net offset in mV is shown to the right of the parameter value.                 |
| 11-14 | Out offset 1-4 type | 0      | 2     | 0       |      | Sets the unit for the corresponding 'Out offset' parameter. The options are V (Volts), mV (millivolts) and semitones (multiples of 83mV, corresponding to semitone steps of a 1V/octave pitch CV). |

|       | Name               | Min    | Max   | Default | Unit | Description   |
|-------|--------------------|--------|-------|---------|------|---|
| 15-38 | Mix N->M           | -200   | 200   | 0       | %    | These 24 parameters set the mix matrix. E.g. 'Mix 5->2' sets the amount of input 5 that will be summed into output 2. A negative amount indicates that the signal will be inverted.         |
| 39-44 | In offset 1-6      | -10000 | 10000 | 0       |      | Input offsets for inputs 1-6. The unit of the offset depends on the corresponding 'In offset type' parameter. The net offset in mV is shown to the right of the parameter value.            |
| 45-50 | In offset 1-4 type | 0      | 2     | 0       |      | Sets the unit for the corresponding 'In offset' parameter. The options are the same as for 'Out offset type' above.   |
| 51-54 | Out Quantize 1-4   | 0      | 3     | 0       |      | Sets the quantization for outputs 1-4. The output quantization is applied after the output offset.  |
| 55-60 | In Quantize 1-6    | 0      | 3     | 0       |      | Sets the quantization for inputs 1-6. The input quantization is applied after the input offset.   |
| 61-64 | Smoothing 1-4      | 0      | 1000  | 0       |      | Sets the amount of smoothing applied to the coefficients of the mixes for outputs 1-4 (so for example "Smoothing 1" applies smoothing to "Out offset 1" and the six "Mix N->1" parameters). |

### Quantization options

The following values are available for the Out Quantize 1-4 and In Quantize 1-6 parameters.

| Value | Name      | Description  |
|-------|-----------|--|
| 0     | Off       | No quantization.   |
| 1     | V         | Quantization to whole Volts.   |
| 2     | semitones | Quantization to multiples of 83mV, corresponding to semitone steps of a 1V/octave pitch CV.                    |
| 3     | oct->semi | Quantization to octaves, and then scaling by 1/12, so the output is a semitone value per octave. <sup>17</sup> |

<sup>17</sup> This somewhat curious scheme was added to address a specific customer request. If you're interested, read the discussion [here](https://modwiggler.com/forum/viewtopic.php?p=3377946#p3377946) (https://modwiggler.com/forum/viewtopic.php?p=3377946#p3377946).



## 2 – Augustus Loop



Augustus Loop is a *disting EX* implementation of one of Expert Sleepers' oldest products, the VST plug-in of the same name ([here](#)<sup>18</sup>). Essentially, it's a tape-inspired stereo delay.

The delay time can be dialled in manually, or set by tap tempo or a clock input. The longest delay possible is around 44 seconds.

Being a tape delay, you can change the tape speed via CV. Patching an LFO into here is your route to all manner of subtle detuning or extreme mangling effects. You can also stop and reverse the tape.

There is an option to run the delay signal through an 'effects loop', allowing you to insert other effects or processing into the guts of the delay.

Note that the 'Pitch CV' input changes the tape speed. It is labelled pitch rather than speed to emphasise the fact that it is scaled 1V/octave.

<sup>18</sup> <https://expert-sleepers.co.uk/augustusloop.html>

This diagram is reproduced from the VST plug-in user manual, and explains the signal flow graphically:

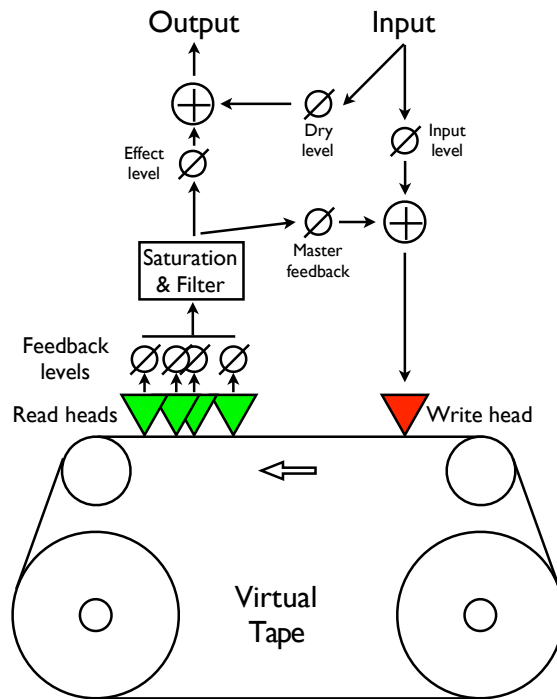

There are four 'tape read heads' with independent delay times and stereo positions, allowing for straight stereo delays, ping pong delays, or hybrid multi-tap style effects.

### Algorithm-specific display



The bottom line of the display shows the current feedback, the tape direction, and the delay time.

### Outputs

Outputs 1 & 2 are a mix of the dry and delay signals according to the 'Dry gain' and 'Effect gain' parameters.

Outputs 3 & 4 are the delay signal only, or the effects loop output, if active.

### Parameters

|     | Name             | Min  | Max | Default | Unit | Description   |
|-----|------------------|------|-----|---------|------|---|
| 1-6 | Attenuverter 1-6 | -200 | 200 | 100     | %    | Applies an attenuverter to the corresponding input. A negative value indicates that the CV will be inverted.            |
| 7   | Time (coarse)    | 0    | 437 | 10      |      | Sets the delay time, in multiples of 100ms. The coarse and fine delay times are added to produce the actual delay time. |

|    | <b>Name</b>      | <b>Min</b> | <b>Max</b> | <b>Default</b> | <b>Unit</b> | <b>Description</b>  |
|----|------------------|------------|------------|----------------|-------------|---|
| 8  | Time (fine)      | -100       | 100        | 0              | ms          | Sets an adjustment to the delay time, in milliseconds. The coarse and fine delay times are added to produce the actual delay time.            |
| 9  | Delay multiplier | 0          | 23         | 15             |             | A multiplier to apply to the delay time set by the parameters, the tap tempo, or the clock. See below for the available values.               |
| 10 | Feedback         | 0          | 100        | 50             | %           | The master delay feedback amount.   |
| 11 | Dry gain         | -40        | 6          | 0              | dB          | The amount of the dry signal to mix into the outputs. At “-40” there is no dry signal at all i.e. it's actually $-\infty$ dB.                 |
| 12 | Effect gain      | -40        | 6          | -3             | dB          | The amount of the effect (delay) signal to mix into the outputs. At “-40” there is no effect signal at all i.e. it's actually $-\infty$ dB.   |
| 13 | L-L Time         | 0          | 100        | 100            | %           | Scales the delay time of the left-to-left feedback path, as a percentage of the master delay time.  |
| 14 | L-R Time         | 0          | 100        | 50             | %           | Scales the delay time of the left-to-right feedback path, as a percentage of the master delay time.   |
| 15 | R-L Time         | 0          | 100        | 50             | %           | Scales the delay time of the right-to-left feedback path, as a percentage of the master delay time.   |
| 16 | R-R Time         | 0          | 100        | 100            | %           | Scales the delay time of the right-to-right feedback path, as a percentage of the master delay time.  |
| 17 | L-L Level        | 0          | 100        | 100            | %           | Scales the amount of the delayed left signal mixed into the left feedback path.   |
| 18 | L-R Level        | 0          | 100        | 0              | %           | Scales the amount of the delayed left signal mixed into the right feedback path.  |
| 19 | R-L Level        | 0          | 100        | 0              | %           | Scales the amount of the delayed right signal mixed into the left feedback path.  |
| 20 | R-R Level        | 0          | 100        | 100            | %           | Scales the amount of the delayed right signal mixed into the right feedback path.   |
| 21 | Mono-ize         | 0          | 100        | 0              | %           | Reduces the stereo width of the incoming signal. At zero the signal is reduced to mono, at a pan position set by the 'Initial pan' parameter. |
| 22 | Initial pan      | -100       | 100        | -100           |             | Sets the pan position of the mono-ized signal. -100 is fully left; 100 is fully right.  |
| 23 | Input level      | 0          | 100        | 100            | %           | Attenuates the input signal fed to the tape write head.   |

|    | <b>Name</b>       | <b>Min</b> | <b>Max</b> | <b>Default</b> | <b>Unit</b> | <b>Description</b>   |
|----|-------------------|------------|------------|----------------|-------------|--|
| 24 | Pitch inertia     | 0          | 125        | 64             |             | Sets the amount of 'inertia' or slew on the pitch CV input. At zero, the tape speed follows the pitch input closely; at the maximum value, pitch changes are quite gradual.                  |
| 25 | Stop tape         | 0          | 1          | 0              |             | When set to '1', the tape speed is set to zero. Note that the Pitch inertia affects how quickly the tape stops and starts.   |
| 26 | Reverse tape      | 0          | 1          | 0              |             | When set to '1', the tape is reversed. Note that the Pitch inertia affects how quickly the tape reverses.  |
| 27 | Mono input        | 0          | 1          | 0              |             | If '0', inputs 1 & 2 are used as a stereo input. If '1', only input 1 is used, as a mono input (leaving input 2 free for parameter mapping).   |
| 28 | Sample rate       | 0          | 1          | 1              |             | Controls the sample rate at which the algorithm runs. At the default '1' the algorithm runs at full speed (96kHz). At '0' the algorithm runs at 48kHz, which doubles the maximum delay time. |
| 29 | Bit depth         | 0          | 1          | 1              |             | Controls the bit depth used in the delay memory (note, not the bit depth used in any other processing). Settings this to '0' (16 bit) doubles the maximum delay time.                        |
| 30 | Inertia free      | 0          | 1          | 0              |             | Enables 'Inertia free' mode. See below.  |
| 31 | Inertia fade time | 1          | 1000       | 100            | ms          | The fade time to use when in Inertia free mode.  |
| 32 | Pitch CV input    | 0          | 6          | 5              |             | The CV input to use for pitch, or "0" for none.  |
| 33 | Clock input       | 0          | 6          | 3              |             | The CV input to use as the clock, or "0" for none. The delay time is set as the time between two rising clock edges.   |
| 34 | Tap tempo         | 0          | 1          | 0              |             | When this parameter transitions from 0 to 1, the algorithm acts on a tap tempo event. See tap tempo, below.  |
| 35 | Clocks required   | 1          | 10         | 1              |             | Sets the number of consistent clocks required to change the delay time. See below.   |
| 36 | Filter type       | 0          | 400        | 0              |             | Sets the filter type. See below.   |
| 37 | Filter freq       | 0          | 127        | 64             |             | Sets the filter frequency.   |
| 38 | Filter Q          | 0          | 100        | 20             |             | Sets the filter resonance.   |
| 39 | FX Loop position  | 0          | 2          | 0              |             | Enables the effects loop and sets in position the signal flow. See below.  |
| 40 | FX Loop input     | 0          | 10         | 5              |             | Sets the effects loop input. See below.  |

|    | Name       | Min | Max | Default | Unit | Description  |
|----|------------|-----|-----|---------|------|--|
| 41 | Clear loop | 0   | 1   | 0       |      | When set to 1, instigates a rapid clear of the delay buffer (while maintaining passthrough of the dry signal). |

### Default mappings

Input 4 is mapped to 'Input level'.

The 'L' knob is mapped to 'Feedback'.

The 'L' button is mapped to 'Tap tempo'.

'Clock input' defaults to input 3.

'Input level' defaults to input 4.

'Pitch CV input' defaults to input 5.

### Delay time multipliers

| Parameter value | Multiplier | Parameter value | Multiplier | Parameter value | Multiplier |
|-----------------|------------|-----------------|------------|-----------------|------------|
| 0               | 1/64       | 8               | 3/16       | 16              | x1.5       |
| 1               | 1/48       | 9               | 1/4        | 17              | x2         |
| 2               | 1/32       | 10              | 5/16       | 18              | x3         |
| 3               | 1/24       | 11              | 1/3        | 19              | x4         |
| 4               | 1/16       | 12              | 3/8        | 20              | x5         |
| 5               | 1/12       | 13              | 1/2        | 21              | x6         |
| 6               | 1/8        | 14              | 3/4        | 22              | x8         |
| 7               | 1/6        | 15              | x1         | 23              | x16        |

### Tap tempo

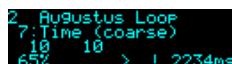

The 'Tap tempo' parameter allows for a tap tempo function. Typically you would map this to a button push, or a MIDI event. By default it is mapped to the 'L' button.

Two taps are required to set the delay time. Taps more than 11 seconds apart are ignored. When the module is 'listening' for a second tap, a “!” is shown in the display, as in the screenshot above.

### Clocks required

When using the clock input, the algorithm's default behaviour is to follow every clock pulse and immediately change the delay time. This is appropriate if you're using a clock with variable timing (perhaps the gate output from a sequencer rather than a clock *per se*).

However, sometimes you're actually wanting a steady clock, but occasionally the time between clocks changes anyway – for example, if the clock is coming from your DAW or sequencer, the clock will stop when the transport stops, and then the first clock when the transport starts will be interpreted as a really long clock (the time between stopping and starting the transport).

The 'Clocks required' parameter is a solution to this problem. By raising the value above '1', you're

telling the algorithm to only change the delay time when it receives a number of clocks of the same time in succession ('same' here means within 10%) - so it will ignore the rogue clock you get from stopping and starting the transport.

## ***Inertia free mode***

“Inertia free” mode relates to the algorithm's behaviour when the delay time is changed, either by changing the master delay time, the multiplier, or the four L-L, L-R, etc. times.<sup>19</sup>

When inertia free mode is not activated, the effect is as if the physical tape heads on a tape machine were slid along the tape to adjust the write/read head gap. This results in a characteristic and fairly drastic pitch slew sound.

When inertia free mode is activated, the algorithm crossfades between the old and new delay times, which is much more subtle effect. The length of the crossfade can be set with the 'Inertia fade time' parameter.

Activating inertia free mode forces the algorithm into 48kHz operation.

## ***Filter***

A second order state variable filter is available within the delay feedback path. The 'Filter type' parameter lets you smoothly fade between the various responses – 'thru' (i.e. no filtering), low pass, band pass, high pass, and back to thru.

## ***Effects Loop***

### **Video**

Enabling the 'FX Loop position' (i.e. setting it to something other than Off) breaks the internal delay feedback path and sends it out of and back into the module, allowing you to insert other effects or processing into the delay. Note that this is different to simply inserting another effect after the delay output – using the effects loop, each delay repeat is progressively more processed by the external effects.

Simple ideas include putting external VCAs in the loop to control the amount of feedback. Or you could put other delays, reverbs, or pitch effects (e.g. chorus) into the loop. Putting a pitch shifter into the loop gives you the classic “pitch spiralling off to infinity” sound.

The two options for the effects loop position are 'Pre-Filter' and 'Post-Filter', which as you might expect places the external loop either before or after the filter, giving you the option of filtering before you send the audio to the external effects, or filtering the result that comes back in.

The 'FX Loop input' parameter allows you to choose which input(s) to use for the effects loop return. If a single input is chosen, that input is used as both the left and right return signals. If an input pair is chosen, that pair is used as a stereo return.

---

<sup>19</sup> Granted, the name of this parameter isn't particularly well chosen, but this is what it's called in the VST version, and we're sticking with it for the sake of consistency.

### 3 – SD Multisample

[Video pt1](#) 

[Video pt2](#) 

```
3: SD Multisample
7: Folder
5
AB: Soft. Pro - PedOn
```

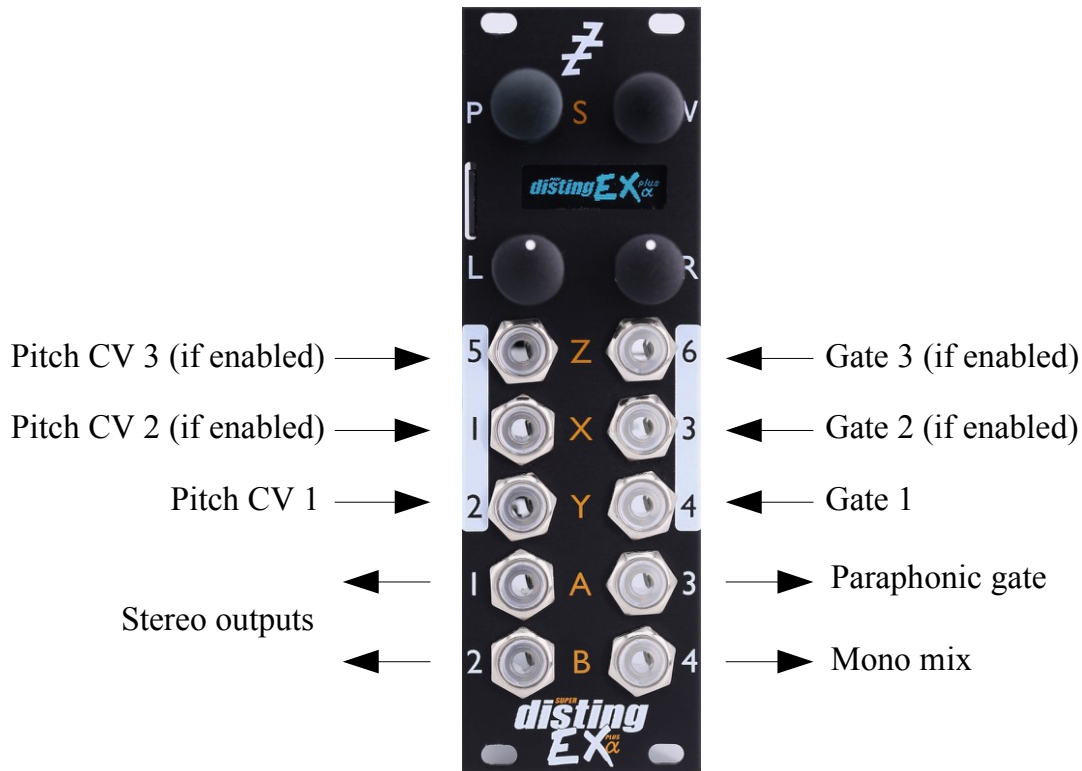

The SD Multisample algorithm is an 8 voice polyphonic sample playback instrument, playing WAV files from the MicroSD card. It can have up to 3 input CV/gate pairs, or can be played via MIDI. It supports both velocity switches and round robins per sample.

There is also a chord and arpeggio generator, based on that in the Expert Sleepers [General CV](#)<sup>20</sup> module.

The algorithm has built in EQ and a delay/echo effect.

The gate inputs are velocity sensitive – the voltage of the gate signal is used like the velocity of a MIDI note. 5V corresponds to maximum velocity.

Please see the section on WAV file naming conventions, below.

The algorithm supports microtonal tunings using Scala or MTS – see 'Scala support' below.

#### Algorithm-specific display

```
PedOn_C4.wav 60 60
18: Max voices
8
-- 62 76 76 76 26 -- --
```

If the Folder parameter is current, the bottom line shows the folder name. Otherwise, it shows the file numbers being played by the 8 voices, or "--" if a voice is not playing. The top line shows

<sup>20</sup> <https://expert-sleepers.co.uk/generalcv.html>

information for the highest active voice: the file name, the file's natural pitch, and its switch setting.

## Inputs

The 'Input mode' parameter controls how many of the module's inputs are used as CV/gate inputs. The options are as follows. Remember that holding 'V' shows you what the inputs are being used for.

|                             |   |
|-----------------------------|---|
| <b>No CV/Gate inputs</b>    | Select this if you're playing the module by MIDI or I2C and want the maximum number of CV inputs for parameter mapping. |
| <b>1 CV/Gate pair</b>       | Uses input 2 for pitch and 4 for gate.  |
| <b>2 CV/Gate pairs</b>      | As above plus input 1 for pitch and 3 for gate.   |
| <b>3 CV/Gate pairs</b>      | As above plus input 5 for pitch and 6 for gate.   |
| <b>2 CVs/1 Gate</b>         | Uses inputs 1 & 2 for pitch and 4 for gate.   |
| <b>3 CVs/1 Gate</b>         | Uses inputs 1, 2 & 5 for pitch and 4 for gate.  |
| <b>4 CVs/1 Gate</b>         | Uses inputs 1, 2, 5 & 6 for pitch and 4 for gate.   |
| <b>5 CVs/1 Gate</b>         | Uses inputs 1, 2, 3, 5 & 6 for pitch and 4 for gate.  |
| <b>2x 2 CVs/1 Gate</b>      | Two sets: 1 & 2 (pitch)/4 (gate), 5 & 6 (pitch)/3 (gate).   |
| <b>3 CVs/Gate + CV/Gate</b> | Two sets: 1, 2 & 5 (pitch)/4 (gate), 6 (pitch)/3 (gate).  |

## Outputs

The algorithm's outputs depend on the 'Output mode' parameter value. The options are:

|                         |  |
|-------------------------|--|
| <b>All summed 1/2</b>   | Outputs 1 & 2 are the main stereo outputs.<br>Output 4 is a mono mix of outputs 1 & 2.<br>Output 3 is a 'paraphonic gate'.   |
| <b>Per gate 1/2-3/4</b> | Outputs 1/2 and 3/4 are two stereo pairs. Voices are assigned to one of the two pairs depending on which gate input triggered them.                                  |
| <b>Per gate 1-2-3</b>   | Outputs 1, 2 and 3 are three mono outputs. Voices are assigned to one of the three depending on which gate input triggered them.<br>Output 4 is a 'paraphonic gate'. |

There are two choices of what is output as a 'paraphonic gate'. The first outputs a gate as long as any voices are playing; the second outputs a gate as long as any keys are held. This is set via the algorithm's menu:

```
ns SD Multisample Pr
```

```
SD Multisample  
tions Options Optio
```

```
Options  
k Paraphonic gate E
```

```
Paraphonic gate  
0 Voices playing
```



The output modes with stereo outputs also have alternative spread modes, which determines the effect of the 'Output spread' parameter:

|                      |   |
|----------------------|---|
| <b>Spread mode 1</b> | Voices are spread across the stereo field from left to right.   |
| <b>Spread mode 2</b> | Voices are spread across the stereo field in an alternating left/right manner, by a small amount for voices 1/2, increasing up to voices 7/8. |

## MIDI support

This algorithm recognises note on, note off, and pitch bend messages. It also recognises sustain (CC# 64) and All Notes Off (CC# 123 value 0), so these CCs are not available for MIDI mapping.

Notes received over MIDI (and I2C) use the 'Arpeggio 3 mode' and 'Arpeggio 3 range', and the 'Min note 3' and 'Max note 3', parameters.

Whether or not the algorithm responds to MIDI notes, and the range of notes to respond to, can be set from the algorithm's menu:

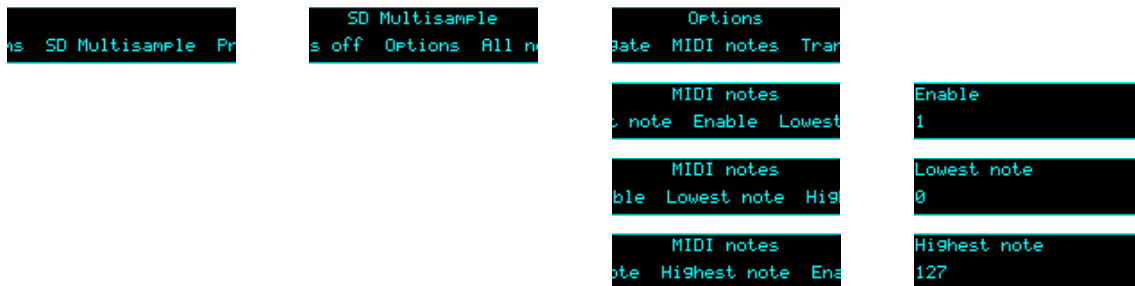

The 'Delay time' parameter can optionally follow MIDI clock. This is also enabled via the menu:



When following MIDI clock, the parameter page shows 'MIDI', as well as the selected clock division and the effective time in milliseconds:

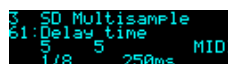

If the MIDI receive channel is set to 'MPE', this algorithm supports per-note pitch bend.

## All notes off

If you encounter stuck notes or other issues, an 'All notes off' function is available from the algorithm's menu.

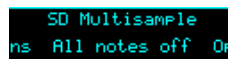

## Parameters

|     | Name             | Min  | Max | Default | Unit | Description  |
|-----|------------------|------|-----|---------|------|--|
| 1-6 | Attenuverter 1-6 | -200 | 200 | 100     | %    | Applies an attenuverter to the corresponding input. A negative value indicates that the CV will be inverted. |
| 7   | Folder           | 0    | 999 | 0       |      | The folder on the MicroSD card to load the samples from.   |

|       | Name             | Min  | Max | Default | Unit  | Description  |
|-------|------------------|------|-----|---------|-------|--|
| 8     | Attack time      | 0    | 127 | 0       |       | The envelope attack time. Range 1ms-15s, or zero at value '0'.   |
| 9     | Decay time       | 0    | 127 | 60      |       | The envelope decay time. Range 20ms-15s.   |
| 10    | Sustain level    | 0    | 127 | 127     |       | The envelope sustain level.  |
| 11    | Release time     | 0    | 127 | 77      |       | The envelope release time. Range 10ms-30s. The value 127 means “infinite” - the sample will play forever or until it stops, depending on whether it is looped or one-shot.                       |
| 12    | Octave           | -8   | 8   | 0       |       | Transposes the whole instrument in octaves.  |
| 13    | Transpose        | -60  | 60  | 0       |       | Transposes the whole instrument in semitones.  |
| 14    | Fine tune        | -100 | 100 | 0       | cents | Tunes the whole instrument in cents.   |
| 15    | Gain             | -40  | 24  | 0       | dB    | Applies an output gain (before saturation, if enabled). The default level is intended to be appropriate for playing chords – if you're playing monophonic lines you may like to boost the level. |
| 16    | Saturation       | 0    | 1   | 1       |       | Enables a soft saturation stage at the output. This will prevent harsh digital clipping, at the expense of some colouration of the sound when driven loud.                                       |
| 17    | Sustain          | 0    | 1   | 0       |       | Activates sustain (notes remain playing when the gate goes low).   |
| 18    | Max voices       | 1    | 8   | 8       |       | Sets the maximum number of simultaneous voices.  |
| 19    | Bend range       | 0    | 48  | 2       |       | The pitch bend range, in semitones. Applies both to MIDI pitch bend, and to CV pitch bend, in which case a CV of $\pm 5V$ maps to the chosen bend range.   |
| 20    | Pitch bend input | 0    | 6   | 0       |       | The pitch bend input, or “0” for none.   |
| 21-28 | Voice 1-8 detune | -100 | 100 | 0       | cents | Sets a per-voice detune. This could be used for example to mimic an old polysynth with a badly tuned voice card.   |
| 29    | Chord enable     | 0    | 7   | 0       |       | Enables the chord generator function. The chord generator can be on or off globally, or per gate (MIDI/I2C counts as gate 3).  |
| 30    | Chord key        | -12  | 12  | 0       |       | The key of the chord generator. “0” is C, “1” is C $\sharp$ /D $\flat$ etc.  |
| 31    | Chord scale      | 0    | 8   | 0       |       | The scale of the chord generator. See below for the options.   |
| 32    | Chord shape      | 0    | 13  | 0       |       | The shape of the chord generator. See below  |

|       | Name               | Min  | Max | Default | Unit | Description   |
|-------|--------------------|------|-----|---------|------|---|
|       |                    |      |     |         |      | for the options.  |
| 33    | Chord inversion    | 0    | 3   | 0       |      | The chord inversion. For example the first inversion takes the first note of the chord and moves it an octave up, so the lowest note in the chord is now the second (e.g. C E G becomes E G C). See e.g. <a href="#">here</a> <sup>21</sup> for a fuller explanation of inversions. |
| 34-36 | Arpeggio 1-3 mode  | 0    | 14  | 0       |      | The arpeggiator mode for each CV/gate input pair. See below for the options.  |
| 37-39 | Arpeggio 1-3 range | 1    | 3   | 1       |      | When set to 1, the arpeggio is simply the notes formed by the chord. When set to 2 or 3, a copy of the chord is appended to the pattern, one or two octaves higher, creating a longer pattern that spans multiple octaves.  |
| 40    | Scala/MTS          |      |     | 0       |      | Sets the Scala scale or MTS tuning to use. See below.   |
| 41    | Scala KBM          |      |     | 0       |      | Sets the Scala keyboard map to use. See below.  |
| 42    | Folder 2           | -1   | 999 | -1      |      | The folder on the MicroSD card to load the samples from for notes triggered by the second CV/gate pair, or -1 to use the primary folder.  |
| 43    | Folder 3           | -1   | 999 | -1      |      | The folder on the MicroSD card to load the samples from for notes triggered by the third CV/gate pair and by MIDI/I2C, or -1 to use the primary folder.   |
| 44    | Min note 1         | 0    | 127 | 0       |      | The lowest note to respond to on the first CV/gate pair.  |
| 45    | Max note 1         | 0    | 127 | 127     |      | The highest note to respond to on the first CV/gate pair.   |
| 46    | Min note 2         | 0    | 127 | 0       |      | The lowest note to respond to on the second CV/gate pair.   |
| 47    | Max note 2         | 0    | 127 | 127     |      | The highest note to respond to on the second CV/gate pair.  |
| 48    | Min note 3         | 0    | 127 | 0       |      | The lowest note to respond to on the third CV/gate pair, and on MIDI/I2C.   |
| 49    | Max note 3         | 0    | 127 | 127     |      | The highest note to respond to on the third CV/gate pair, and on MIDI/I2C.  |
| 50    | Output spread      | -100 | 100 | 0       | %    | Sets the amount by which voices are panned, according to the 'Output mode'. See above.  |
| 51    | Delay mode         | 0    | 2   | 0       |      | The type of delay effect: 'Off', 'Stereo' or 'Ping-pong'.   |

21 [https://en.wikipedia.org/wiki/Inversion\\_\(music\)#Inversions](https://en.wikipedia.org/wiki/Inversion_(music)#Inversions)

|       | Name                 | Min  | Max  | Default | Unit  | Description  |
|-------|----------------------|------|------|---------|-------|--|
| 52    | Delay level          | -40  | 0    | -3      | dB    | The level of the delay effect. '-40' is treated as $-\infty$ dB.   |
| 53    | Delay time           | 1    | 1365 | 500     | ms    | The delay time, in milliseconds.   |
|       | <i>or</i>            | 1    | 18   | 5       |       | The delay time, if following MIDI clock.   |
| 54    | Delay feedback       | 0    | 100  | 50      | %     | The delay feedback.  |
| 55    | Tone bass            | -240 | 240  | 0       | 0.1dB | Bass EQ cut or boost.  |
| 56    | Tone treble          | -240 | 240  | 0       | 0.1dB | Treble EQ cut or boost.  |
| 57    | Break time           | 0    | 1000 | 0       | ms    | The 'break' time for chords, or “0” for off. See below.  |
| 58    | Break direction      | 0    | 2    | 0       |       | The 'break' direction. See below.  |
| 59-66 | Voice 1-8 bend input | 0    | 6    | 0       |       | The per-voice pitch bend input, or “0” for none.   |
| 67    | Output mode          | 0    | 4    | 0       |       | Sets how the outputs are used. Also controls the effect of the 'Output spread' parameter. See above.   |
| 68    | Input mode           | 0    | 9    | 1       |       | Sets how the inputs are used for CV/gate control. See above.   |
| 69    | Sustain mode         | 0    | 1    | 0       |       | Sets the behaviour of the sustain function. The options are “Synth” (sustained notes cannot be retriggered) and “Piano” (sustained notes can be retriggered).  |
| 70    | MIDI vel curve       | 0    | 3    | 0       |       | Selects a velocity curve applied to incoming MIDI notes.   |
| 71    | Arp reset input      | 0    | 6    | 0       |       | The input to use as the arpeggiator reset, or “0” for none. A trigger pulse into this input will reset the arpeggiator back to step 1.   |
| 72    | Gate offset          | 0    | 496  | 0       |       | Offsets (delays) the gate inputs relative to the pitch inputs. This is useful to allow pitch CVs to settle before they are sampled on the rising gate, and also to cope with modules which output both a pitch and gate but change their gate first. <sup>22</sup> |
| 73    | Round robin mode     | 0    | 3    | 0       |       | Sets how round-robins are used. See below.   |

## Default mappings

Input 3 is mapped to 'Sustain'.

<sup>22</sup> For example, while making the demo movie for this algorithm, we discovered that a suitable value for the René mk2 is around 330.

## Note ranges

The Min/Max note 1-3 parameters (parameters 56-61) set the range of incoming notes that will trigger a response. Note that in chord mode it is still possible that notes will sound outside of this range. For example, if the chord shape is Octave, and the min/max notes are C1-B1 (a single octave), playing C1-B1 on a keyboard will produce both octaves, even though the higher octave is outside of the note range.

## Tap tempo

When the 'Delay time' parameter is current, pressing the 'R' button acts as a 'tap tempo' function to set the delay time (instead of resetting the parameter to its default value).

## Chord scales

The available scales are as follows.

| Name             | Notes                                 | Example (on C)                                   |
|------------------|---------------------------------------|--|
| Major            | 1, 3, 5, 6, 8, 10, 12                 | C D E F G A B                                    |
| Natural Minor    | 1, 3, 4, 6, 8, 9, 11                  | C D E $\flat$ F G A $\flat$ B $\flat$            |
| Dominant         | 1, 3, 5, 6, 8, 10, 11                 | C D E F G A B $\flat$                            |
| Fully Diminished | 1, 3, 4, 6, 7, 9, 10, 12              | C D E $\flat$ F F $\sharp$ A $\flat$ A B         |
| Dominant Dim     | 1, 2, 4, 5, 7, 8, 10, 11              | C D $\flat$ E $\flat$ E F $\sharp$ G A B $\flat$ |
| Augmented        | 1, 4, 5, 8, 9, 12                     | C E $\flat$ E G A $\flat$ B                      |
| Whole Tone       | 1, 3, 5, 7, 9, 11                     | C D E F $\sharp$ G $\sharp$ A $\sharp$           |
| Chromatic        | 1, 2, 3, 4, 5, 6, 7, 8, 9, 10, 11, 12 |  |
| Harmonic Minor   | 1, 3, 4, 6, 8, 9, 12                  | C D E $\flat$ F G A $\flat$ B                    |

## **Chord shapes**

The available shapes are as follows.

| <b>Name</b>      | <b>Notes (within scale)</b> | <b>Example (in C major)</b> |
|------------------|-----------------------------|-----------------------------|
| None             | 1                           | C                           |
| Octave           | 1-1(8ve)                    | C C(8ve)                    |
| Two Octaves      | 1-1(8ve)-1(15ma)            | C C(8ve) C(15ma)            |
| Root/Fifth       | 1-5                         | C G                         |
| Root/Fifth + 8ve | 1-5-1(8ve)                  | C G C(8ve)                  |
| Triad            | 1-3-5                       | C E G                       |
| Triad + 8ve      | 1-3-5-1(8ve)                | C E G C(8ve)                |
| Sus4             | 1-4-5                       | C F G                       |
| Sus4 + 8ve       | 1-4-5-1(8ve)                | C F G C(8ve)                |
| Sixth            | 1-3-5-6                     | C E G A                     |
| Sixth + 8ve      | 1-3-5-6-1(8ve)              | C E G A C(8ve)              |
| Seventh          | 1-3-5-7                     | C E G B                     |
| Seventh + 8ve    | 1-3-5-7-1(8ve)              | C E G B C(8ve)              |
| Ninth            | 1-3-5-7-2(8ve)              | C E G B D                   |

## Arpeggio modes

The 'Arpeggio 1-3 mode' parameters specify the way in which the notes from the chord are played to create an arpeggio. The options are as follows:

| Name      | Behaviour  | Example (on C major triad) |
|-----------|--|----------------------------|
| Up        | Notes are played from lowest to highest.   | C E G C E G ...            |
| Down      | Notes are played from highest to lowest.   | G E C G E C ...            |
| Alt       | Notes are played alternately up and down.  | C E G E C E G ...          |
| Alt2      | Notes are played alternately up and down, repeating the top & bottom notes.                            | C E G G E C C E G ...      |
| Up -8ve   | See below.   |                            |
| Down -8ve | See below.   |                            |
| Alt -8ve  | See below.   |                            |
| Alt2 -8ve | See below.   |                            |
| Step Up   | The lowest note alternates with the other notes in the chord, in rising order.                         | C E C G C E C G ...        |
| Step Down | The highest note alternates with the other notes in the chord, in descending order.                    | G E G C G E G C ...        |
| Random    | Notes are played in a random order.  |                            |
| Random2   | Notes are played in a random order, except that the same note cannot be played twice in a row.         |                            |
| Random3   | The notes in the chord are played in a random permutation, then another random permutation, and so on. |                            |
| As Played | Notes are played according to the order of their CV inputs. See below.                                 |                            |

The “-8ve” modes differ from the basic modes in how they treat the Range parameter (above), for shapes which end in “+8ve”. As an example, consider the Triad+8ve shape in C major, which contains the notes:

C E G C(8ve)

If Range is set to 2, this pattern is repeated an octave higher, so modes Up/Down/Alt/Alt2 will arpeggiate the notes:

C E G C(8ve) C(8ve) E(8ve) G(8ve) C(15ma)

Note how C(8ve) is repeated. The “-8ve” modes skip this repeated note, so for example the Up-8ve mode will play:

C E G C(8ve) E(8ve) G(8ve) C(15ma) C E G ...

## **Chords, arpeggios, and multiple CV inputs per gate**

How these features interact warrants some clarification.

### **[Video](#)**

If the input mode is one in which there are multiple pitch CVs per gate, the chord generation is applied to each pitch CV. For example, if you supply the notes C and D, and set the chord generation to 'triad' in C major, you'll get the notes C, E, G, D, F, A.

If you enable arpeggiation, but not chords, then the arpeggiation is over the input pitch CVs. So for example if your input mode is "3 CVs/1 gate" then the arpeggiator will run over the three notes supplied to the CV inputs. Note that this is useful even if you have a single pitch CV per gate, since you can still use the arpeggio range setting to get octaves.

If chords and arpeggiation are both enabled, then the arpeggio is over all the notes generated by the chords. In most cases, the notes are sorted and then the Up, Down, etc. direction imposed. The exception is 'As Played' mode – in this mode the notes are ordered according to the CV input that generated them. In the above example, 'As Played' mode would give you C, E, G, D, F, A, in that order, whereas 'Up' would give you C, D, E, F, G, A.

## **WAV file defaults**

Loop setting: the default is for a file to be looping if it has loop markers defined in the file, or to be one-shot otherwise. This can be overridden in the playlist.

## **Scala and MTS (MIDI Tuning Standard) support**

### **[Video](#)**

You can apply microtonal tunings in this algorithm using files in [Scala](#)<sup>23</sup> format or tuning dumps in [MTS](#)<sup>24</sup> format. In both cases, files may be placed on the MicroSD card, or sent to the module over MIDI. When active, tuning is applied both when playing the algorithm over MIDI and when playing using CV/gate.

Scala files can be generated by the Scala application, any another tool that writes Scala-format files (for example, [Scale Workshop](#)<sup>25</sup>), or even written by hand.

Some example files are included on the MicroSD card that comes with the module. Scale files need to go in the folder named 'scl', and keyboard map files need to go in the folder named 'kbn'.

Note that the 'playlist-scales.txt' file required by the dual mode algorithms is not used here. It suffices to simply put the .scl and .kbn files into the right folders.

The MTS support is designed to be compatible with MTS-ESP by [ODDSound](#)<sup>26</sup>, which provides a convenient way to experiment with tunings in real time, though the files used follow the generic MIDI [bulk tuning dump specification](#)<sup>27</sup>.

---

23 <http://huygens-fokker.org/scala/>

24 [https://en.wikipedia.org/wiki/MIDI\\_tuning\\_standard](https://en.wikipedia.org/wiki/MIDI_tuning_standard)

25 <https://sevish.com/scaleworkshop/>

26 <http://www.oddsound.com/>

27 <https://www.midi.org/specifications/midi1-specifications/midi-1-addenda/midi-tuning-updated>



If using MTS-ESP MIDI Client, choose the 'MTS SYSEX' option:

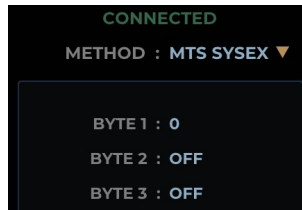

MTS dumps should be placed in a folder named 'MTS' on the MicroSD card, and the files should have the extension '.syx'. The file should be exactly 408 bytes in size; if the file you have is a different size, it is in the wrong format.

Select the scale and keyboard mapping using the parameters. If the scale is 'None', no tuning will be applied. Likewise, if using Scala (as opposed to MTS) and the keyboard mapping is 'None', no tuning will be applied.



Positive values of the Scala/MTS parameter select Scala operation; negative values select MTS operation.

Setting Scala/MTS to '1' chooses the scl file supplied over MIDI. Note that sending Scala over MIDI is not a standard operation – to our knowledge it is currently only supported by our own tool, which you'll find in [our GitHub](#)<sup>28</sup>.



Scala/MTS values of '2' or higher select scl files from the MicroSD card.

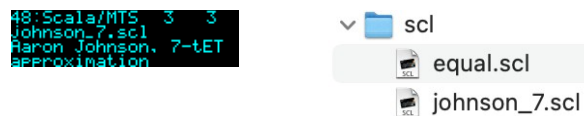

Similarly, setting Scala KBM to '1' chooses the file supplied over MIDI, and values of '2' or higher select kbm files from the MicroSD card.



If there is a mismatch between the two files (for example, if the keyboard map refers to a scale degree not present in the scale), then this is indicated in the display, and no tuning is applied.



Settings Scala/MTS to '-1' chooses the MTS tuning supplied over MIDI. Note that it is possible to save this tuning data as a file on the MicroSD card – see below.



Scala/MTS values of '-2' or below select MTS files from the MicroSD card.



When using MTS, the Scala KBM parameter is not relevant and is ignored. “Using MTS” is shown

<sup>28</sup> [https://github.com/expertsleepersltd/distingEX\\_tools](https://github.com/expertsleepersltd/distingEX_tools)

in the display.

```
SD Multisample
49: scala.kbm
1: Using MTS
willelmba24.kbm
```

## SoundFont®s

[Video](#) 

[SoundFont](#)<sup>29</sup> is a file format (usually using the .sf2 extension) which rolls up multiple audio samples with data describing how they are to be combined into an instrument. Such samples are ideally matched for use in this algorithm. Sadly the way the data is arranged in the file format does not lend itself to an efficient implementation on the module, so we have not supported being able to directly load .sf2 files from the SD card. However, we have published an open source tool to extract the samples from .sf2 files and to create a folder of WAV files, named appropriately for this algorithm. The tool is [here](#)<sup>30</sup>.

### Creating your own multisamples

Creating new sample sets for this algorithm is simply a matter of collecting WAV files in a folder on the MicroSD card and naming them appropriately (see below). However there are tools available to automate the sampling of existing instruments.

The disting EX's own WAV Recorder algorithm includes auto-sampling functionality which will automatically sample any instrument it can trigger via CV/gate or MIDI. The files it records to the MicroSD card are named correctly for this algorithm.

There are also computer-based tools available to automatically sample virtual instruments. Once such is [Bliss](#)<sup>31</sup> by DiscoDSP. There is a tutorial video showing the use of Bliss to prepare instruments for the disting EX [here](#)<sup>32</sup>.

Apple's Logic Pro has a built-in Auto Sampler. We have provided a script to convert its output into a format suitable for the disting EX [here](#)<sup>33</sup>.

### Transpose limit

```
SD Multisample Pr
Options Options Optio
Options Transpose limit E
```

It is possible to set a 'transpose limit', which limits the amount by which samples can be pitched up. This is to avoid glitches that can occur when trying to stream samples from the MicroSD card faster than the card can support.

```
Transpose limit
0 Unlimited
Transpose limit
12 semitones
```

When this feature is active, samples that would be transposed up from their natural pitch by more than the specified amount are dropped by octaves to bring them back into range.

29 <https://en.wikipedia.org/wiki/SoundFont>  
30 [https://github.com/expertsleepersltd/sf2\\_to\\_dex](https://github.com/expertsleepersltd/sf2_to_dex)  
31 <https://www.discodsp.com/bliss/>  
32 <https://www.youtube.com/watch?v=U7Vdi4ph7Ko>  
33 [https://github.com/expertsleepersltd/distingEX\\_tools](https://github.com/expertsleepersltd/distingEX_tools)

## Broken chords



The 'Break time' and 'Break direction' parameters allow you to automatically 'break' chords i.e. the notes are played one at a time, instead of simultaneously. With a small time, this gives a 'strumming' effect, though you can specify much longer times if you wish so each note is quite distinctly separated.

Note that this applies to multiple notes triggered when using a single gate input with multiple CV inputs, as well as when chord mode is activated.

The 'Break direction' allows you to specify whether the chord is played from bottom to top (up), from top to bottom (down), or alternately up and down.

The arpeggio reset input, if used, also serves to reset the alternating break direction to up.

## Round robin mode

The 'Round robin mode' parameter lets you choose how round-robin variants of the same sample are chosen. The options are as follows:

| Value | Name       | Description  |
|-------|------------|--|
| 0     | Sequential | The round-robins are played in numerical order.  |
| 1     | Random     | The round-robins are played in a random order.   |
| 2     | Random2    | The round-robins are played in a random order, except that the same round-robin cannot be played twice in a row. |
| 3     | Random3    | The round-robins are played in a random permutation, then another random permutation, and so on.                 |

## 4 – SD 6 Triggers

[Video](#) 

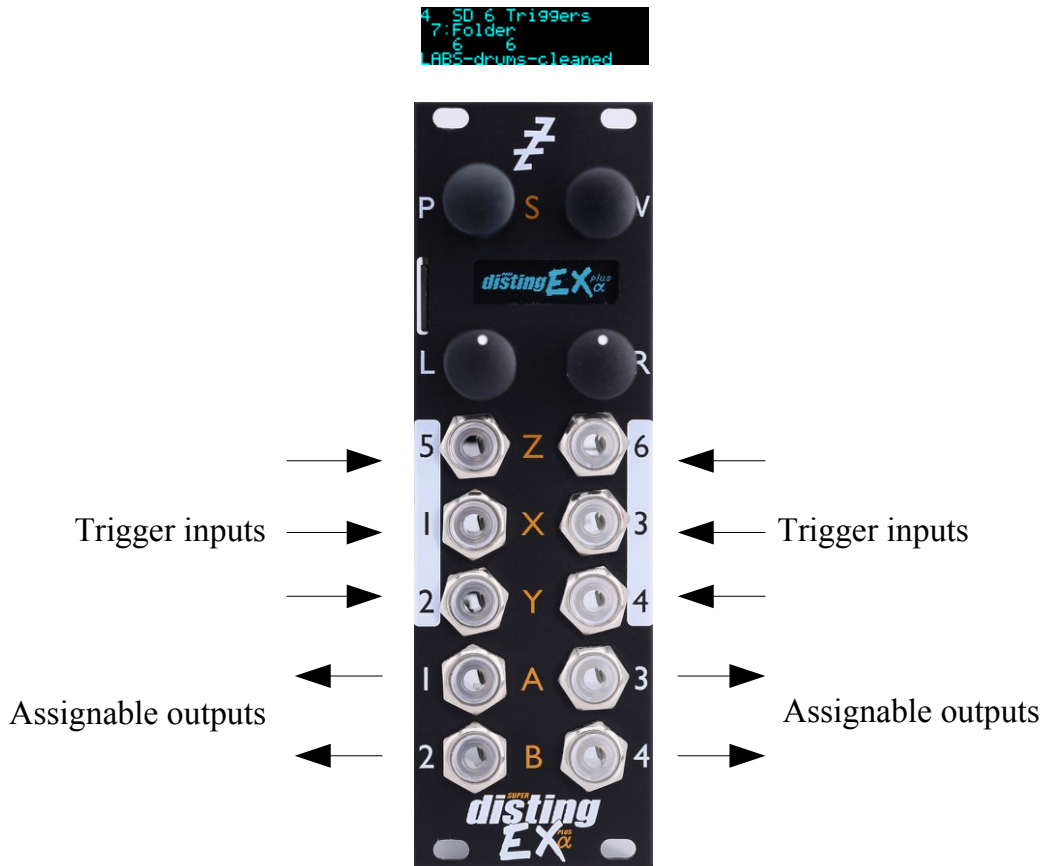

This algorithm, primarily designed for drum sample playback, offers 6 voices with independent triggers and sample selection.

It is somewhat like the disting mk4's 'I-8 Dual Audio Playback with Z Speed' but much more capable.

It supports both velocity switches and round robins per sample.

The gate inputs are velocity sensitive – the voltage of the gate signal is used like the velocity of a MIDI note. 5V corresponds to maximum velocity.

The trigger for each voice is the correspondingly numbered input i.e. input 1 triggers voice 1 etc.

Please see the section on WAV file naming conventions, below.

### **Algorithm-specific display**

```
4: SD 6 Triggers
7: Folder
6: 6
8: crash1.ff.close.RR1
```

If the Folder parameter is current, the bottom line shows the folder name.

If one of the six Sample parameters is current, the bottom line shows the file name. If the voice is playing, the line above also shows the velocity, the velocity switch number and the round-robin number. If there are no round-robins or velocity switches, that number is replaced by “>”.

## Outputs

Outputs 1-4 are audio outputs. Each voice can be routed to one or a pair of these.

## ES-5 outputs

If an ES-5 is connected (see above), the first 6 outputs of the ES-5 emit “end of sample” triggers when the corresponding voice's sample comes to an end.

## Trigger inputs

By default, each input serves as a trigger input for the correspondingly numbered voice. However, if you want to trigger the voice by MIDI or I2C and use an input for CV mapping instead, the trigger input can be disabled from the algorithm's menu:



## MIDI support

Six consecutive MIDI notes trigger voices 1-6 respectively. By default these are notes 48-53 but this can be changed via the algorithm's menu:



Whether or not the algorithm responds to MIDI notes, and the range of notes to respond to, can be set from the algorithm's menu (in the same way as illustrated for the SD Multisample algorithm, above).

This algorithm also recognises All Sound Off (CC# 120 value 0) and All Notes Off (CC# 123 value 0), so these CCs are not available for MIDI mapping.

## All notes off/all sound off

The MIDI 'all notes/sound off' functions are also available for manual use via the menu:

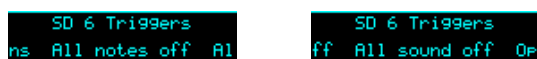

'All notes off' forces the immediate release of any held notes. Notes that have release sections will continue to sound.

'All sound off' immediately silences any active notes. Release sections will be curtailed.

## Parameters

|     | Name             | Min  | Max | Default | Unit | Description  |
|-----|------------------|------|-----|---------|------|--|
| 1-6 | Attenuverter 1-6 | -200 | 200 | 100     | %    | Applies an attenuverter to the corresponding input. A negative value indicates that the CV will be inverted. |
| 7   | Folder           | 0    | 999 | 0       |      | The folder on the MicroSD card to load the samples from.   |

|       | Name               | Min  | Max | Default | Unit  | Description  |
|-------|--------------------|------|-----|---------|-------|--|
| 8-13  | Sample 1-6         | -1   | 999 | 0-5     |       | The sample chosen for the voice. The special value “-1” disables the voice.<br>Pressing 'R' while one of these parameters is current triggers the sample (for previewing).   |
| 14-19 | Output 1-6         | 1    | 8   | 5       |       | The output assignment for the voice.<br>1-4 give a single output, as numbered.<br>5 gives outputs 1/2 as a stereo pair.<br>6 gives outputs 3/4 as a stereo pair.<br>7 gives outputs 1/2 as a stereo pair <b>and</b> output 3 as a mono output.<br>8 gives outputs 1/2 as a stereo pair <b>and</b> output 4 as a mono output. |
| 20-25 | Gain 1-6           | -40  | 6   | -6      | dB    | The gain for each voice.   |
| 26-31 | Pan 1-6            | -100 | 100 | 0       |       | The pan position for each voice (if assigned to a stereo output).  |
| 32-37 | Env Time 1-6       | 0    | 100 | 100     |       | The (release) envelope time. The value 100 means “infinite” - the sample will play forever or until it stops, depending on whether it is looped or one-shot.   |
| 38-43 | Transpose 1-6      | -60  | 60  | 0       |       | The transposition of each voice, in semitones.   |
| 44-49 | Fine tune 1-6      | -100 | 100 | 0       | cents | The fine tuning of each voice, in cents.   |
| 50-55 | Choke group 1-6    | 0    | 3   | 0       |       | The voice's 'choke group', or “0” for off. When a voice in a choke group is triggered, it ends the playback of any other voices in the same choke group.   |
| 56-61 | Start offset 1-6   | 0    | 999 | 0       | 0.1%  | The position in the sample at which to begin playback, in % of the sample length. The offset in milliseconds is displayed on the bottom line of the display.   |
| 62-65 | Out 1-4 Saturation | 0    | 1   | 1       |       | Enables soft saturation on each output. Saturation prevents harsh digital clipping, at the expense of some colouration of the sound when driven loud.  |
| 66-70 | Folder 2-6         | -1   | 999 | -1      |       | The folder on the MicroSD card to load the samples from for voices 2-6, or -1 to use the primary folder as set by parameter 7.   |
| 71    | Round robin mode   | 0    | 3   | 0       |       | Sets how round-robins are used. See above.   |

### **WAV file defaults**

Loop setting: the default is for a file to be one-shot (not looping). This can be overridden in the playlist.

## 5 – WAV Recorder

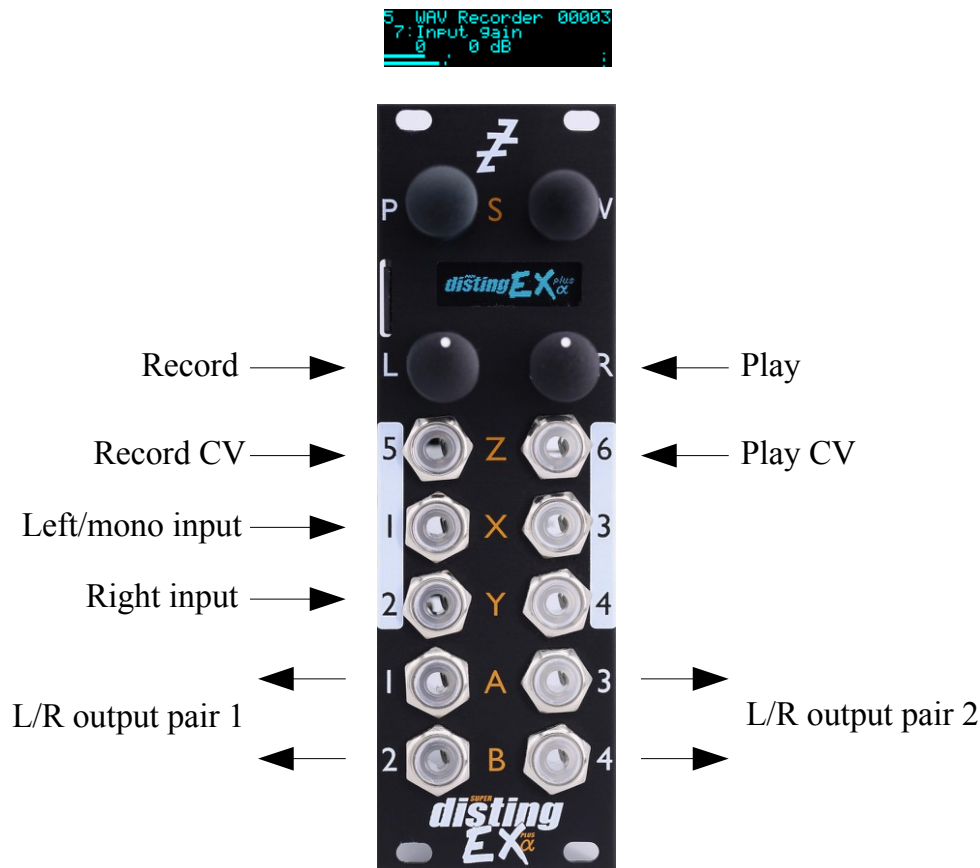

This algorithm records audio (or CV) to the MicroSD card as a WAV file. It can record up to six channels of audio at 48 or 96kHz, 16 or 24 bit. It can also play previous recordings, though the various WAV playing algorithms offer many more possibilities.

There is an “auto-sampler” feature for automatically capturing multi-sampled instruments.

### Recording

The files are placed in a folder called “!RECORD” (which will be created by the module if it does not exist). They are named e.g. “REC00001.WAV”, where the number increases for each new recording. It can be controlled by pushing the module buttons, or by CV.

Do not remove the card or power off the module while it is recording.  
Doing so may corrupt the card.

Inputs 1 & 2 are the stereo inputs (use input 1 for mono). When recording more than two channels, use inputs 3-6 as required.

Press 'L' to start and stop recording. Press 'R' to start and stop playback of the last recording. Both knobs can be 'locked' to prevent accidental activation. This is done via the 'Record enable' and 'Playback enable' parameters, which are by default mapped to the 'L' and 'R' knobs – so effectively the record and playback knobs are locked by turning them anticlockwise. If the button is pressed while locked, the display indicates this:



Recording can also be controlled by a CV into input 5. Playback can be controlled by input 6. Note that when recording five or six channels, these inputs are used for audio. Be sure to switch to five or six channels *before* connecting the audio signals to the inputs, or you risk attempting to start/stop recording & playback at audio rates, which will not end well.

## Multi-channel audio

Recording of more than two channels at once places great demands on the MicroSD card. In our tests we have achieved reliable recording of six channels at 48kHz, 24 bit. You are unlikely to achieve 96kHz recordings of this many channels.

You are advised to thoroughly test your card before relying on it to make any critical recordings.

Currently, playback is only possible for mono or stereo files.

We have published a desktop tool to split multi-channel files into stereo & mono files, which is [here](#)<sup>34</sup>.

Since the module has more inputs than outputs it is not possible to monitor all 6 inputs on separate outputs. The “Thru routing” parameters let you choose which inputs you monitor, and on which outputs (mixing inputs that share the same output routing).

## Algorithm-specific display



The bottom of the screen shows a level meter. Each channel has a peak hold and a clip indicator. (The image above shows that the left channel has clipped.) The number at the top right is the number of the last recording – this will be incremented when recording starts.

While recording, the display looks like this:

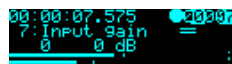

The top line changes to show the time since recording started, a circle to indicate recording, and a barber pole animation over the recording number.

Below the recording number are two horizontal lines, which will grow from left to right. The top line indicates how much data is being written into a memory buffer; the lower line indicates how this data is being transferred to the card. Ideally these will progress in lock-step. If the top line overtakes the lower line, this indicates that the module has been unable to write data to the card fast enough. Unless your recording is shorter than the module's RAM buffer, it is likely to be incomplete. In this case, use a faster card, or use a lower sample rate or bit depth.

While playing back a recording, the display looks like this:

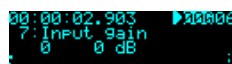

The top line shows the time within the recording, a triangle to indicate playback, and the recording number is superposed with a progress bar indicating the current position within the file.

## Outputs

Outputs 1/2 and 3/4 are stereo pairs, whose exact function can be set with the 'Outputs' parameters.

<sup>34</sup> [https://github.com/expertsleepersltd/split\\_wav](https://github.com/expertsleepersltd/split_wav)



Outputs 3/4 are also used as CV/gate outputs during auto-sampling.

## Parameters

|       | Name             | Min   | Max  | Default | Unit    | Description   |
|-------|------------------|-------|------|---------|---------|---|
| 1-6   | Attenuverter 1-6 | -200  | 200  | 100     | %       | Applies an attenuverter to the corresponding input. A negative value indicates that the CV will be inverted.                                |
| 7     | Input gain       | 0     | 24   | 0       | dB      | The gain to apply to the inputs.  |
| 8     | Sample rate      | 0     | 1    | 0       |         | The sample rate of the recording. The options are 48kHz and 96kHz.  |
| 9     | Bit depth        | 0     | 1    | 0       |         | The bit depth of the recording. The options are 16 bit and 24 bit.  |
| 10    | Channels         | 1     | 6    | 2       |         | The number of channels to record.   |
| 11    | Rec CV Mode      | 0     | 1    | 0       |         | If "0", the record CV control (input 5) is a trigger; if "1", a gate.   |
| 12    | Play CV Mode     | 0     | 1    | 0       |         | If "0", the play CV control (input 6) is a trigger; if "1", a gate.   |
| 13    | Play As Loop     | 0     | 1    | 0       |         | Whether to play the recording as a one-shot or a loop.  |
| 14    | Outputs 1/2      | 0     | 2    | 1       |         | Controls what is output on outputs 1/2. See below for details.  |
| 15    | Outputs 3/4      | 0     | 2    | 0       |         | Controls what is output on outputs 3/4. See below for details.  |
| 16    | AS Enable        | 0     | 1    | 0       |         | Enables the auto-sampler.   |
| 17    | AS Start Note    | 0     | 127  | 21      |         | Auto-sampler start note. (MIDI note number; 48 is 0V for the CV output.)  |
| 18    | AS End Note      | 0     | 127  | 108     |         | Auto-sampler end note.  |
| 19    | AS Note Step     | 1     | 127  | 1       |         | Auto-sampler note step.   |
| 20    | AS Vel Sw        | 1     | 9    | 1       |         | Number of auto-sampler velocity switch layers.  |
| 21    | AS RRobins       | 1     | 9    | 1       |         | Number of auto-sampler round-robins.  |
| 22    | AS Coarse        | 0     | 60   | 1       | s       | Auto-sampler note on time (coarse).   |
| 23    | AS Fine          | -1000 | 1000 | 0       | ms      | Auto-sampler note on time (fine).   |
| 24    | AS Gap           | 1     | 600  | 1       | x100 ms | Auto-sampler gap time (time between note-ons i.e. how long to keep recording after the note).   |
| 25    | AS Latency       | 0     | 960  | 0       |         | Auto-sampler latency adjustment.  |
| 26-31 | Thru routing 1-6 | 0     | 6    | 1 or 2  |         | Sets the routing for each input when monitoring. '0' is 'None'; '1' to '4' are outputs 1-4; '5' is outputs 1 and 2; '6' is outputs 3 and 4. |

|    | Name            | Min | Max | Default | Unit | Description   |
|----|-----------------|-----|-----|---------|------|---|
| 32 | AS Min velocity | 0   | 127 | 25      |      | The minimum velocity value to use when auto-sampling with velocity switch layers.   |
| 33 | AS Max velocity | 0   | 127 | 127     |      | The maximum velocity value to use when auto-sampling with velocity switch layers, or the fixed value to use if not using velocity switches. |
| 34 | Playback file   | 0   |     |         |      | Chooses the file to be played when starting playback.   |
| 35 | Record enable   | 0   | 1   | 1       |      | If set to zero, recording cannot be started or stopped by pressing 'L'.   |
| 36 | Playback enable | 0   | 1   | 1       |      | If set to zero, playback cannot be started or stopped by pressing 'R'.  |

### **Default mappings**

The 'L' knob is mapped to 'Record enable'.

The 'R' knob is mapped to 'Playback enable'.

### **Output options**

The following options apply to the “Outputs 1/2” and “Outputs 3/4” parameters.

|   |           |   |
|---|-----------|---|
| 0 | Thru      | Output the input signals (controlled by the “Thru routing” parameters).                         |
| 1 | Thru/Play | Output the input signals, unless playback is active, in which case output the playback signals. |
| 2 | Play      | Output the playback if active, else nothing.  |

### **Auto-sampler**

[Video](#) 

[Video](#) 

The auto-sampler feature of this algorithm allows you to automatically create multi-sampled instruments in a format that can be immediately used by the SD Multisample algorithm, by triggering an external synth (by MIDI or CV/gate) and recording the resulting audio.

Use the parameters to set the range of notes to be sampled, and the step size (e.g. every note, every fourth note etc.). You can also choose to sample multiple velocity levels per note, and multiple round-robins of each note.

The selected sample rate, bit depth, and channel count parameters apply as usual.

To begin, set “AS Enable” to 1. Connect your MIDI synth via the breakout, or connect a synth via CV/gate to outputs 3 (CV) and 4 (gate).

Set the length of the note to be played using the “AS Coarse” and “AS Fine” parameters (these are simply added). Set the gap between notes (which should allow time for the release section of the note) with “AS Gap”.

When the auto-sampler is enabled, you can preview the note timings by pressing the 'R' knob.

```
5 Wav Recorder 00008
Auto-sampling
Testing timing 6
```

This will generate a MIDI note and a gate of the set length, after which “Testing timing” will continue to be shown for the gap time.

This function also helps to set up the latency adjustment. This is unlikely to be necessary when using CV/gate but there will be some delay when triggering a MIDI synth, which if not accounted for will result in a short silence at the start of every sample. To the right of “Testing timing” will appear a number (6 in the screenshot above) which is the number of frames between the note on and the module receiving audio above a threshold (of 100mV). Set the “AS Latency” parameter to a little less than this value. Experiment for best results.

Press the 'L' knob to begin the auto-sampling process.

```
00:00:00.865 ● 00008
Auto-sampling 0040
022_A#0.wav
:
```

A new folder will be created on the card named e.g “AUTO0001” and the samples placed therein.

The current filename being recorded is shown on the display.

Pressing 'L' again during auto-sampling will cancel it (leaving any samples recorded so far in place).

## 6 – Multi-Switch

[Video](#) 

```
6 Multi-Switch
14:R outputs
6 6 2-3
3:1 -> 2
```

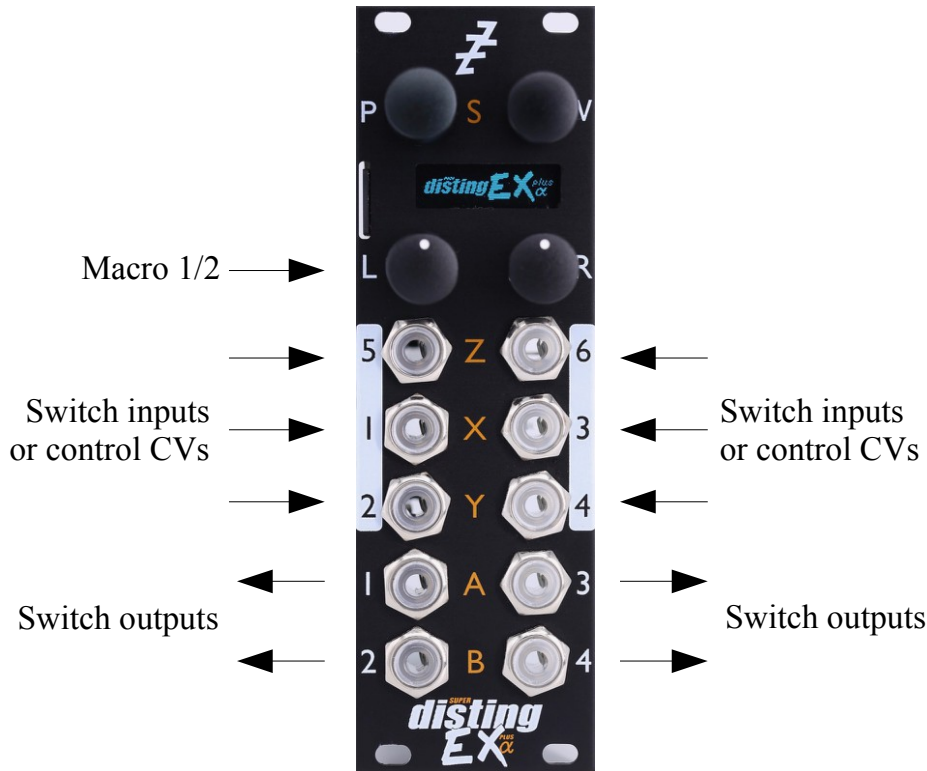

This algorithm offers six highly configurable sequential or voltage controlled switches. Being DC-coupled, it can switch audio or CVs.

Each switch consists of two sub-switches: an input sub-switch, to select one of the module's six inputs, and an output sub-switch, to select one of the module's four outputs. The selected input is routed to the selected output. When multiple switches share the same output, their signals are summed.

Each sub-switch can crossfade when transitioning, for click-free switches (when the fade is very short) or noticeable blends between sources/targets (when the fade is long).

The switches can be controlled by CV inputs, or by one of the 'Macro' parameters, which can in turn be controlled by one of the mapping sources (knobs, buttons, MIDI or i2c).

### Parameters

The six switches have identical parameters. The parameters for switch A are spelled out below; those for switches B-F follow the same pattern.

|     | Name                | Min  | Max | Default | Unit | Description  |
|-----|---------------------|------|-----|---------|------|--|
| 1-6 | Attenuverter<br>1-6 | -200 | 200 | 100     | %    | Applies an attenuverter to the corresponding input. A negative value indicates that the CV will be inverted. |

|       | <b>Name</b>        | <b>Min</b> | <b>Max</b> | <b>Default</b> | <b>Unit</b> | <b>Description</b>  |
|-------|--------------------|------------|------------|----------------|-------------|---|
| 7-12  | Macro 1-6          | 0          | 127        | 0              |             | Can be mapped (to CV, MIDI etc.) and used as a control source by the switches.  |
| 13    | A inputs           | 0          | 31         | 0              |             | The inputs for the switch. See 'inputs choices'.  |
| 14    | A outputs          | 0          | 13         | 0              |             | The outputs for the switch. See 'outputs choices'.  |
| 15    | A in control       | 0          | 36         | 0              |             | The control source for the input switch. See 'control sources'.   |
| 16    | A in control type  | 0          | 9          | 0              |             | The type of control source for the input switch. Changes the options available for 'in control'. See 'control types'.   |
| 17    | A out control      | 0          | 36         | 0              |             | The control source for the output switch. See 'control sources'.  |
| 18    | A out control type | 0          | 9          | 0              |             | The type of control source for the output switch. Changes the options available for 'out control'. See 'control types'. |
| 19    | A reset            | 0          | 12         | 0              |             | The reset source for the switch. See 'reset sources'.   |
| 20    | A fade             | 0          | 1000       | 1              | ms          | The switch's crossfade time, in milliseconds.   |
| 21-28 |                    |            |            |                |             | Switch B parameters   |
| 29-36 |                    |            |            |                |             | Switch C parameters   |
| 37-44 |                    |            |            |                |             | Switch D parameters   |
| 45-52 |                    |            |            |                |             | Switch E parameters   |
| 53-60 |                    |            |            |                |             | Switch F parameters   |

### ***Default mappings***

The 'L' knob is mapped to 'Macro 1'.

The 'L' button is mapped to 'Macro 2'.

### **Inputs choices**

| Value | Switch inputs | Value | Switch inputs | Value | Switch inputs |
|-------|---------------|-------|---------------|-------|---------------|
| 0     | None          | 10    | 4-5           | 20    | 2-3-4-5       |
| 1     | 1             | 11    | 5-6           | 21    | 3-4-5-6       |
| 2     | 2             | 12    | 6-1           | 22    | 4-5-6-1       |
| 3     | 3             | 13    | 1-2-3         | 23    | 5-6-1-2       |
| 4     | 4             | 14    | 2-3-4         | 24    | 6-1-2-3       |
| 5     | 5             | 15    | 3-4-5         | 25    | 1-2-3-4-5     |
| 6     | 6             | 16    | 4-5-6         | 26    | 2-3-4-5-6     |
| 7     | 1-2           | 17    | 5-6-1         | 27    | 3-4-5-6-1     |
| 8     | 2-3           | 18    | 6-1-2         | 28    | 4-5-6-1-2     |
| 9     | 3-4           | 19    | 1-2-3-4       | 29    | 5-6-1-2-3     |
|       |               |       |               | 30    | 6-1-2-3-4     |
|       |               |       |               | 31    | 1-2-3-4-5-6   |

### **Outputs choices**

| Value | Switch outputs | Value | Switch outputs | Value | Switch outputs |
|-------|----------------|-------|----------------|-------|----------------|
| 0     | None           | 5     | 1-2            | 10    | 2-3-4          |
| 1     | 1              | 6     | 2-3            | 11    | 3-4-1          |
| 2     | 2              | 7     | 3-4            | 12    | 4-1-2          |
| 3     | 3              | 8     | 4-1            | 13    | 1-2-3-4        |
| 4     | 4              | 9     | 1-2-3          |       |                |

### **Control sources (when type is not 'Link')**

A sub-switch is triggered when its chosen reset input goes over 1V, or when the chosen Macro goes over 64.

| Value | Control source | Value | Control source | Value | Control source |
|-------|----------------|-------|----------------|-------|----------------|
| 0     | None           |       |                |       |                |
| 1     | Input 1        | 5     | Input 5        | 9     | Macro 3        |
| 2     | Input 2        | 6     | Input 6        | 10    | Macro 4        |
| 3     | Input 3        | 7     | Macro 1        | 11    | Macro 5        |
| 4     | Input 4        | 8     | Macro 2        | 12    | Macro 6        |

### Control sources (when type is 'Link')

| Value | Control source | Value | Control source | Value | Control source |
|-------|----------------|-------|----------------|-------|----------------|
| 0     | None           |       |                |       |                |
| 1     | A plus 0       | 13    | C plus 0       | 25    | E plus 0       |
| 2     | A plus 1       | 14    | C plus 1       | 26    | E plus 1       |
| 3     | A plus 2       | 15    | C plus 2       | 27    | E plus 2       |
| 4     | A plus 3       | 16    | C plus 3       | 28    | E plus 3       |
| 5     | A plus 4       | 17    | C plus 4       | 29    | E plus 4       |
| 6     | A plus 5       | 18    | C plus 5       | 30    | E plus 5       |
| 7     | B plus 0       | 19    | D plus 0       | 31    | F plus 0       |
| 8     | B plus 1       | 20    | D plus 1       | 32    | F plus 1       |
| 9     | B plus 2       | 21    | D plus 2       | 33    | F plus 2       |
| 10    | B plus 3       | 22    | D plus 3       | 34    | F plus 3       |
| 11    | B plus 4       | 23    | D plus 4       | 35    | F plus 4       |
| 12    | B plus 5       | 24    | D plus 5       | 36    | F plus 5       |

### Control types

| Value | Name      | Description  |
|-------|-----------|--|
| 0     | None      |  |
| 1     | Trig fwds | The chosen source is used as a trigger to advance the switch one step forwards.  |
| 2     | Trig rev  | The chosen source is used as a trigger to advance the switch one step backwards.   |
| 3     | Trig pong | The chosen source is used as a trigger to advance the switch, the direction alternating on each pass. For example, if the chosen inputs/outputs are 1-2-3, the switch will advance like so: 1-2-3-2-1-2-3-2-1-etc. |
| 4     | Trig rand | The chosen source is used as a trigger – the switch adopts a randomly chosen position on each trigger.   |
| 5     | Unipolar  | The chosen source is used directly to select a switch position. Values from 0V to 5V map to switch positions from first to last.   |
| 6     | Bipolar   | The chosen source is used directly to select a switch position. Values from -5V to 5V map to switch positions from first to last.  |
| 7     | Uni rev   | The chosen source is used directly to select a switch position. Values from 0V to 5V map to switch positions from last to first.   |
| 8     | Bi rev    | The chosen source is used directly to select a switch position. Values from -5V to 5V map to switch positions from last to first.  |
| 9     | Link      | The switch position is linked to another switch's position, plus an offset.  |

## **Reset sources**

A sub-switch is reset when its chosen reset input goes over 1V, or when the chosen Macro goes over 64.

| <b>Value</b> | <b>Reset source</b> | <b>Value</b> | <b>Reset source</b> | <b>Value</b> | <b>Reset source</b> |
|--------------|---------------------|--------------|---------------------|--------------|---------------------|
| 0            | None                |              |                     |              |                     |
| 1            | Input 1             | 5            | Input 5             | 9            | Macro 3             |
| 2            | Input 2             | 6            | Input 6             | 10           | Macro 4             |
| 3            | Input 3             | 7            | Macro 1             | 11           | Macro 5             |
| 4            | Input 4             | 8            | Macro 2             | 12           | Macro 6             |



## 7 – Looper

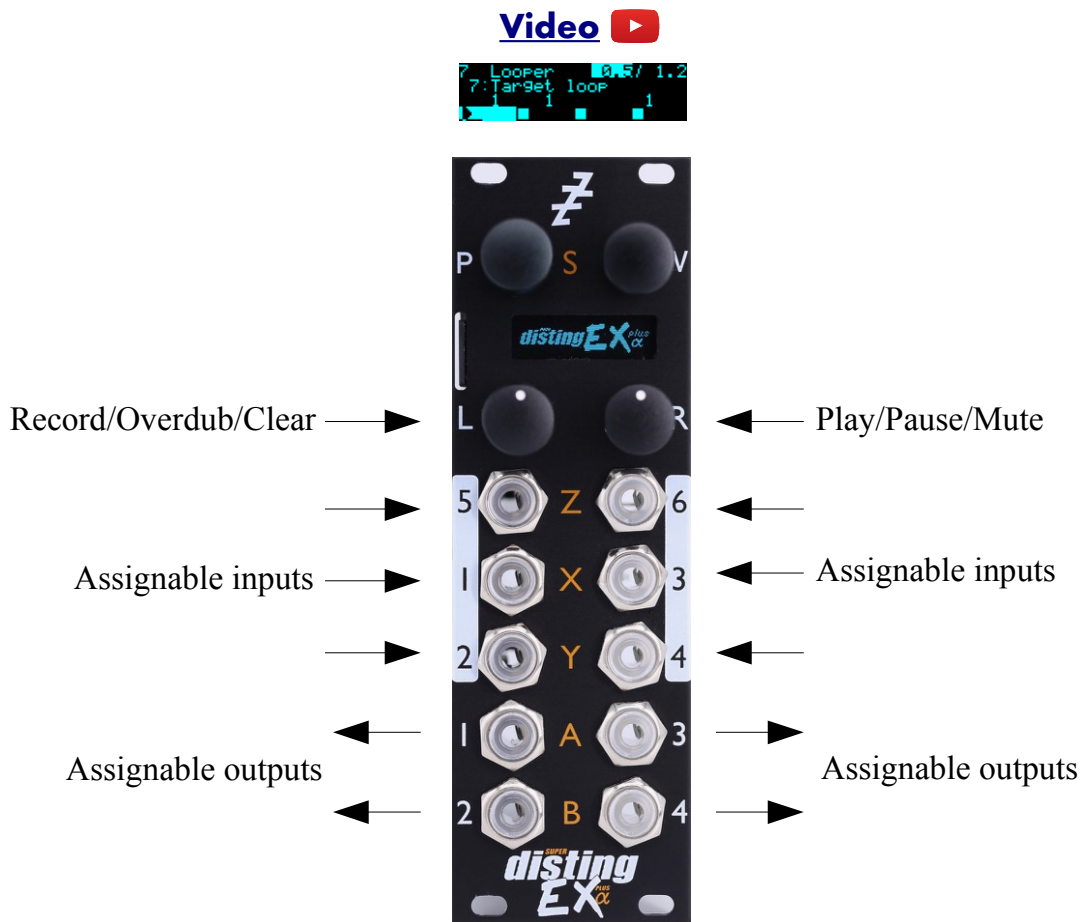

This algorithm provides four simultaneous loopers, with two button record/play/overdub control in the manner of many stomp-box loopers.

The loopers may be 8/16/32 bit, and mono or stereo, with corresponding adjustments to maximum loop time. For the default 16 bit mono, each of the four loops has a maximum time of about 21s.

The inputs and outputs of each looper are highly configurable; they can all share inputs & outputs, or all have their own dedicated inputs and outputs, or something in between. There are output mix controls for the loops themselves, and for a monitor mix (i.e. a mix of the looper inputs).

Loops can have crossfades, they can fade in and out, and overdubbing can fade in and out, all of which is designed to make it easy to achieve smooth, ambient looping.

All looping operations can also be synchronised to a clock input, if tight rhythmic looping is more your thing.

Loops may also be reversed, and played at half speed (an octave down).

### **Loop targets and commands**

Fundamental to the operation of the Looper is the concept of the 'target loop'. This is how we expose the control of four independent loopers through a two button interface. The record/overdub/play/pause/reverse/octave down operations are considered as 'commands' that apply to whichever loop or loops is the 'target'.

The target loop is set by parameter 7. You may like to map this to a knob for ease of access; or you may not, to avoid the risk of accidentally changing it. Note that special MIDI control of the target loop is provided – see below.

The commands are given by parameters 56-58 & 62. It is implemented this way to give you the flexibility to map these commands to whatever CV, MIDI, i2c, button etc. you like.

The command is given when the parameter changes from '0' to '1'.

## **Basic looping**

The basic procedure is as follows

- Connect an input signal (all loopers default to input 1).
- Choose the target loop.

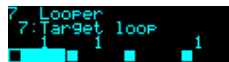

The bottom of the display is divided into four, for the four loopers. Each will initially show a square, which is the 'stopped' symbol. The target loop or loops are shown with inverted colours.

- Press 'L' to begin recording.



The symbol for the target loop will change to a circle, for 'recording'. The recording time will start counting up in the upper right of the display.

- Press 'L' again to end recording and immediately enter playback.

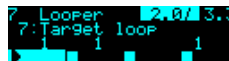

The symbol for the loop will change to a triangle, for 'play'. The upper right area shows the current time in the loop, and the loop length. Both the upper right area and the loop's own rectangle also indicate the position within the loop graphically.

- If the recording approaches the maximum loop time, the upper left of the display will show 'remain:' and the remaining loop time.



Recording will automatically stop once it reaches the maximum time.

Recording can also be ended by pressing 'R'.

## **Recording a blank loop**

Sometimes it is useful to set the loop length without actually recording anything into it. To do this, press 'R' instead of 'L' to begin recording.

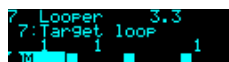

The display will show the record icon (circle) with an 'M' for mute.

## **Pausing/muting/retriggering the loop**

Once a loop is playing, pressing 'R' pauses or mutes the loop, depending on the 'Pause/mute' parameter.

If the loop is paused, the symbol changes to the 'double vertical line' icon:



If the loop is muted, the symbol changes to an 'M':



Pressing 'R' again returns the loop to play mode.



A third option, 'Retrigger', is like Mute except that when the loop starts playing again it does so from the beginning of the loop.

Loops may also be retriggered by setting the 'Play' parameter to '-1'. By default the 'R' button automates the Play parameter between 0 and 1 – you may like to set up a CV Mapping to set Play to -1, thus enabling retriggering of loops via a CV input.

## **Overdubbing**

While a loop is playing, pressing 'L' enters overdub mode. Incoming material is recorded on top of the previous loop. The loop's symbol shows both the play (triangle) and record (circle) icons.



Press 'L' again to stop overdubbing.

## **Clearing the loop**

When a loop is paused or muted, you can clear the loop, which means erasing it completely and returning to 'stopped'.

To do so, hold down the 'L' button.



While you hold the button, the word 'CLEAR' will appear with a graphical countdown. After two seconds, the loop will be cleared.

## **Crossfades**

Each loop can have a crossfade time set, which helps to make smooth loops. Note that raising the crossfade time effectively reduces the loop time, since two passes of the loop have to be overlaid and mixed.

If the crossfade time is set before recording the loop, the recording will run on after the end-of-record command, in order to record extra material for the crossfade. The overall loop time will still be correct i.e. the time between the start- and end-of-record commands.

## **Envelopes**

Two attack-decay envelopes are provided; one for when a loop is started and stopped, and one for when overdubbing starts and ends.

While the loop is in the decay stage, fading out towards pause/mute, a 'v' is indicated in its display.

While the end of overdub decay stage is active, the record indicator (the circle) flashes.

## **Overdub fade**

By default, loops do not fade out. You can use the 'Overdub fade' parameter to choose to fade out previous material while overdubbing new material. Note that the fade stops (i.e. the loop no longer decays) when overdubbing ends.

## **Replace**

If 'Overdub fade' is set to its minimum, none of the previous material is recorded into the loop, at which point the overdub operation is actually a replace operation i.e. the new material completely replaces the previous material.

## **Clocked operation**

If a clock input is chosen, any looping command is deferred until the next clock that arrives.

The options are 'None', one of the module's six inputs, or a MIDI clock divisor.

MIDI clock divisors are specified as e.g. "MIDI 1/4" which means quarter notes; "MIDI 1/8T" means eighth note triplets etc.

When in clocked mode, the 'Lock range' parameter activates automatic re-triggering of the loops to keep them locked to the clock. The parameter specifies a time window around the clock – if a loop would naturally loop during this window, it is retriggered so that it begins exactly on the clock pulse.

## **ES-5 outputs**

If an ES-5 is connected (see above), the outputs of the ES-5 plus any attached ESX-8GT expanders are selectable as the loops' trigger outputs.

## **MIDI support**

MIDI notes 48, 50, 52 & 53 (i.e. C3, D3, E3 & F3) can be used to set the target loop (C is loop 1, D is loop 2 etc.). While keys are held, subsequent presses are additive – that is, you can play a chord to select multiple loops.

MIDI notes 55, 57, 59 & 60 (i.e. G3, A3, B3 & C4) activate Record, Play, Reverse and Octave Down respectively.

These MIDI note numbers can be changed via the algorithm's menu:



Whether or not the algorithm responds to MIDI notes, and the range of notes to respond to, can be set from the algorithm's menu (in the same way as illustrated for the SD Multisample algorithm, above).

## Parameters

|       | Name               | Min  | Max | Default | Unit | Description  |
|-------|--------------------|------|-----|---------|------|--|
| 1-6   | Attenuverter 1-6   | -200 | 200 | 100     | %    | Applies an attenuverter to the corresponding input. A negative value indicates that the CV will be inverted.   |
| 7     | Target loop        | 1    | 15  | 1       |      | Selects which loop(s) will be affected by the Record/Play/Reverse commands.  |
| 8     | Record gain        | -40  | 6   | 0       | dB   | The gain to apply at the loop inputs (does not affect the monitoring levels).  |
| 9-12  | Loop 1-4 input     | 0    | 6   | 1       |      | Which input to use as the loop input, or '0' for 'None'. If the loops are stereo, this parameter selects the left input and the next highest input is used as the right channel input. |
| 13-16 | Loop 1-4 output    | 1    | 6   | 5       |      | The loop output (1-4), or '5' to use outputs 1 & 2 as a stereo pair, or '6' to use outputs 3 & 4 as a stereo pair.   |
| 17-20 | Loop 1-4 pan       | -100 | 100 | 0       | %    | If the loop output is a stereo pair, and the loops are mono, this sets the pan position of the loop.   |
| 21-24 | Loop 1-4 gain      | -40  | 6   | 0       | dB   | The output gain of the loop. '-40' is treated as $-\infty$ dB.   |
| 25-28 | Loop 1-4 x-fade    | 0    | 127 | 0       |      | The loop crossfade time. The control is logarithmic, offering times between 0.1ms and 5 seconds.   |
| 29-32 | Loop 1-4 VCA       | 0    | 6   | 0       |      | The input to use to control the loop level, or '0' for 'None'. If enabled, this is equivalent to putting the loop output through a linear VCA, with 5V being unity gain.               |
| 33-36 | Monitor 1-4 output | 1    | 6   | 5       |      | The monitor output (1-4), or '5' to use outputs 1 & 2 as a stereo pair, or '6' to use outputs 3 & 4 as a stereo pair.  |
| 37-40 | Monitor 1-4 pan    | -100 | 100 | 0       | %    | If the monitor output is a stereo pair, and the loops are mono, this sets the pan position of the monitor signal.  |
| 41    | Monitor 1 gain     | -40  | 6   | 0       | dB   | The monitor mix gain.  |
| 42-44 | Monitor 2-4 gain   | -40  | 6   | -40     | dB   | The monitor mix gain. '-40' is treated as $-\infty$ dB.  |
| 45    | Attack time        | 0    | 127 | 0       |      | The loop attack time (when fading in from pause/mute). The control is logarithmic, offering times between 1ms and 30 seconds.  |
| 46    | Decay time         | 0    | 127 | 0       |      | The loop decay time (when fading out to pause/mute). The control is logarithmic, offering times between 1ms and 30 seconds.  |

|       | Name                | Min  | Max  | Default | Unit   | Description  |
|-------|---------------------|------|------|---------|--------|--|
| 47    | Overdub attack time | 0    | 127  | 0       |        | The loop overdub attack time (when entering overdub). The control is logarithmic, offering times between 1ms and 30 seconds.   |
| 48    | Overdub decay time  | 0    | 127  | 0       |        | The loop overdub decay time (when leaving overdub). The control is logarithmic, offering times between 1ms and 30 seconds.   |
| 49    | Overdub fade        | -240 | 0    | 0       | 0.1 dB | Sets how much the previous loop content will fade out on each pass while overdubbing. '-240' is treated as $-\infty$ dB, at which point the 'overdub' feature is actually 'replace'.                 |
| 50    | Pause/mute          | 0    | 2    | 0       |        | Chooses what happens when the pause/mute command is given. The options are:<br>0 – Pause (loop stops)<br>1 – Mute (loop continues but is silent)<br>2 – Retrigger (as 1 but loop restarts from zero) |
| 51-54 | Trigger 1-4 output  | 0    | 52   | 0       |        | Sets which output to use for a start-of-loop trigger pulse. The options are '0' for 'None', 1-4 for outputs 1-4, or 5-52 for the outputs of an attached ES-5 module.                                 |
| 55    | Clock input         | 0    | 24   | 0       |        | Sets the clock input, or '0' for 'None', or a MIDI clock divisor.  |
| 56    | Record              | 0    | 1    | 0       |        | Controls the 'record/overdub/clear' function. By default this is mapped to the 'L' button.   |
| 57    | Play                | -1   | 1    | 0       |        | Controls the 'play/pause/mute' function. By default this is mapped to the 'R' button. When set to '-1', causes an immediate retrigger of the active loops.   |
| 58    | Reverse             | 0    | 1    | 0       |        | Controls the 'reverse' function.   |
| 59    | Bit depth           | 0    | 2    | 1       |        | Sets the loop bit depth. The options are 8 bit, 16 bit or 32 bit.  |
| 60    | Stereo              | 0    | 1    | 0       |        | Chooses stereo or mono operation.  |
| 61    | Lowpass filter      | 0    | 127  | 127     |        | Sets the frequency of a second order low-pass filter applied to the loop outputs. '127' disables the filter; lower values set the cutoff frequency with a minimum of 200Hz.                          |
| 62    | Octave down         | 0    | 1    | 0       |        | Controls the 'octave down' function.   |
| 63    | Lock range          | 0    | 1000 | 0       | ms     | The lock range when the clock input is active – see above.   |

### **Default mappings**

The 'L' button is mapped to 'Record'.

The 'R' button is mapped to 'Play'.

## Saving/loading loops

The Looper can load WAV files from the MicroSD card into the loops, and can save its loops as WAV files.

When a preset is saved from this algorithm, it automatically saves its loops as WAV files, and loads them when the preset is loaded.

Files are saved and loaded from the Looper's own menu, which is accessed by pressing 'P' in the usual way:



```
Rhythms Looper Preset
```

### Loading a WAV file to a loop

From the Looper menu, select 'Load WAV' and then 'Load loop 1' (or 2, 3, 4):

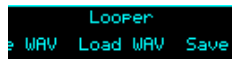

```
Looper  
Load WAV Load WAV Save
```

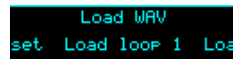

```
Load WAV  
set Load loop 1 Load
```

You can then navigate to the WAV file that you want to load.

### Loading a loop set

A 'loop set' is a set of up to four WAV files, typically saved by this algorithm, which share the same filename but with a “\_1”, “\_2” etc. suffix.

From the 'Load WAV' menu select 'Load loop set':

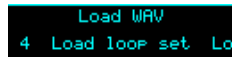

```
Load WAV  
4 Load loop set Load
```

Then navigate to one of the files in the set. The files will be loaded to the loops that correspond to their suffix number.

## Saving loops

From the Looper menu, select 'Save WAV' and then 'Save all loops':

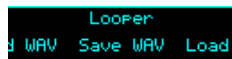

```
Looper  
Load WAV Save WAV Load
```

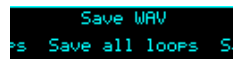

```
Save WAV  
es Save all loops Save
```

Each looper that is not empty will be saved to the MicroSD card as a WAV file, into a folder named “!LOOPER”. A unique filename is automatically generated, starting with “LP” and then a number, and finally a suffix in the format expected by 'Load loop set'.

The filename is displayed when saving is complete:

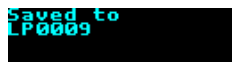

```
Saved to  
LP0009
```

## Saving loops with presets

When a Looper preset is saved, its loops are also saved to the MicroSD card as WAV files.

They are saved into a folder called “!LOOPER”, using a filename created from the preset number and the preset name.

If WAV files for this preset are already present in the folder, they are renamed and moved into a folder called “!LOOPER.BAK”. This extremely conservative behaviour is designed to ensure you

never accidentally lose any recordings, but it may tend to fill up your MicroSD card. Please bear this in mind and occasionally tidy up the card on a computer.



## 8 – Dream Machine



This algorithm is designed to generate drones, allowing the user to explore non-traditional harmonies based on prime ratios. It was inspired by the theories of composer [La Monte Young](#)<sup>35</sup>. An interesting read is the pdf “Notes on The Theatre of Eternal Music” available in a number of places online e.g. [here](#)<sup>36</sup>.

The output is a combination of five sounds – the fundamental and four harmonies. The prime ratios that define the frequency relationships are controlled by parameters.

The algorithm uses wavetable synthesis to generate the tones. Additionally the fundamental may instead be a pure sine, triangle or square wave.

Each tone has a simple attack/release envelope, controlled by its own gate parameter.

By default little is mapped to the CV inputs, and it is perfectly possible to drive the algorithm entirely by hand. You may however like to map the inputs as FM inputs, or to control the gates.

### **Setting the fundamental**

The fundamental is the fixed tone (usually the bass note) that everything else revolves around. You may like to set it to a concert pitch (it defaults to concert B $\flat$ ) or some other frequency (La Monte Young sometimes chose the mains frequency – 60Hz in the USA – or you could tune it to the resonant frequency of whatever environment you find yourself in). It can be dialled in via the

35 [https://en.wikipedia.org/wiki/La\\_Monte\\_Young](https://en.wikipedia.org/wiki/La_Monte_Young)

36 <http://soundartarchive.net/articles/Young-2000-Notes%20on%20his%20Practice.pdf>

parameter (in thousandths of a Hz), or set from the algorithm's menu.

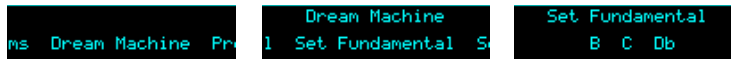

Note that the Hz value shown in the display also takes into account the octave parameter.



## Setting the primes

Parameters 8-11 let you choose the set of prime numbers that will make up the allowable values for the frequency ratios. La Monte Young famously chose the primes 2, 3, 7 & 31, and moreover specifically avoided the prime 5, thereby excluding major thirds from his tunings.

If you want less than four primes, set the unwanted parameters to '1'.

## Setting the frequency ratios

To set the ratios of tones 1-4 relative to the fundamental, set the parameters for the denominator and the four numerators.



When setting the numerators, the pitch of the tone is shown, as well as the ratio reduced to its lowest form. For example 48/32 reduces to 3/2, the familiar form of the perfect fifth in just intonation.



## Outputs

Outputs 1 & 2 are the main stereo mix.

Output 3 is the fundamental waveform (unaffected by its gain and envelope).

Output 4 is the fundamental's envelope.

## Parameters

|     | Name             | Min  | Max   | Default | Unit | Description  |
|-----|------------------|------|-------|---------|------|--|
| 1-6 | Attenuverter 1-6 | -200 | 200   | 100     | %    | Applies an attenuverter to the corresponding input. A negative value indicates that the CV will be inverted.         |
| 7   | Wavetable        | 0    | 999   | 0       |      | Chooses the wavetable from those installed on the MicroSD card. See below.   |
| 8   | Prime 1          | 2    | 32767 | 2       |      | Sets one of the four primes that may be multiplied to create the denominator and numerators of the frequency ratios. |
| 9   | Prime 2          | 1    | 32767 | 3       |      | Sets the second prime.   |
| 10  | Prime 3          | 1    | 32767 | 7       |      | Sets the third prime.  |
| 11  | Prime 4          | 1    | 32767 | 31      |      | Sets the fourth prime.   |

|       | <b>Name</b>  | <b>Min</b> | <b>Max</b> | <b>Default</b> | <b>Unit</b> | <b>Description</b>   |
|-------|--------------|------------|------------|----------------|-------------|--|
| 12    | Fundamental  | 1          | 32767      | 29135          |             | Sets the fundamental frequency, in thousandths of a Hz.  |
| 13    | Octave       | -8         | 8          | 1              |             | Sets an octave shift for the fundamental.  |
| 14    | Denominator  | 1          | 256        | 32             |             | Sets the denominator of the frequency ratios.  |
| 15    | Numerator 1  | 1          | 1024       | 42             |             | Sets the numerator of the frequency ratio of tone 1.   |
| 16    | Numerator 2  | 1          | 1024       | 56             |             | Sets the numerator of the frequency ratio of tone 2.   |
| 17    | Numerator 3  | 1          | 1024       | 62             |             | Sets the numerator of the frequency ratio of tone 3.   |
| 18    | Numerator 4  | 1          | 1024       | 63             |             | Sets the numerator of the frequency ratio of tone 4.   |
| 19    | Gate 0       | 0          | 1          | 0              |             | Gate for the fundamental.  |
| 20-23 | Gate 1-4     | 0          | 1          | 0              |             | Gates for tones 1-4.   |
| 24    | Gain 0       | -40        | 6          | 0              | dB          | Gain for the fundamental.<br>“-40” is treated as $-\infty$ dB.   |
| 25-28 | Gain 1-4     | -40        | 6          | 0              | dB          | Gains for tones 1-4.<br>“-40” is treated as $-\infty$ dB.  |
| 29-32 | Pan 1-4      | -100       | 100        | 0              | %           | Stereo pan position for tones 1-4.   |
| 33    | Wave input   | 0          | 6          | 5              |             | Which input to use to control the position in the wavetable, or '0' for 'None'.  |
| 34    | Wave offset  | -100       | 100        | 0              |             | An offset for the wavetable position, added to that set from the wave input.   |
| 35    | Attack time  | 0          | 127        | 0              |             | Attack time for the envelopes.   |
| 36    | Decay time   | 0          | 127        | 0              |             | Decay time for the envelopes.  |
| 37-40 | FM input 1-4 | 0          | 6          | 0              |             | Which input to use to frequency modulate (FM) tones 1-4, or '0' for 'None'. The inputs are scaled according to the FM Range parameter. |
| 41    | Waveform 0   | 0          | 3          | 0              |             | Chooses the waveform for the fundamental. Options 0-3 are Wavetable, Sine, Triangle and Square, respectively.                          |
| 42    | FM Range     | 0          | 3          | 0              |             | Sets the scaling for the FM inputs. The options are 1Hz/V, 10Hz/V, 100Hz/V or 1kHz/V.  |

### **Default mappings**

The 'L' knob is mapped to 'Wave offset'.

Input 5 is mapped to 'Wave input'.

## ***Fun fact***

This algorithm was road-tested during development in a couple of online gigs, which you can watch [here](#)<sup>37</sup> and [here](#)<sup>38</sup>.

---

37 <https://www.youtube.com/watch?v=zc5ksVeMXFA>

38 <https://www.youtube.com/watch?v=WTw6vz71LJM>

## 9 – Filter Bank



This algorithm provides a bank of eight parallel stereo bandpass filters or resonators. The filters' levels can be controlled manually, via CV, or with envelopes driven from gates, and their pitch can also be set manually or via CV or MIDI. An internal octature LFO is also provided for the levels.

The resonators in particular are good for being played as chords over MIDI, in the manner of the Alesis Quadraverb Plus (see e.g. [here](#)<sup>39</sup>).

### **Filter modes**

The filters can be set to one of three modes: Resonator, Bandpass or Multiband.

Resonators are peaking all-pass filters that greatly emphasise the narrow band of frequencies around their centre frequencies.

Bandpass filters are a basic filter type that attenuate frequencies away from their centre frequencies.

In both of the modes above, all eight filters are completely independent. In Multiband mode however, the filter frequencies set a series of crossover points, such as you might find in a multiband compressor, for example. Therefore the frequencies passed by each band are bounded by its own frequency on the one side, and the frequency of the next band on the other.

<sup>39</sup> <https://www.youtube.com/watch?v=ZOObDS3Hvfuo&t=90>

## Setting the filter frequencies

When set manually from the parameters, the filter frequencies are set in terms of MIDI note numbers. The frequency in Hz is also shown for convenience.



## Outputs

Outputs 1 & 2 are a mix of the dry and filtered signals according to the 'Dry gain' and 'Effect gain' parameters.

Output 3 is a sum of the odd-numbered filters (1, 3, 5 & 7) only.

Output 4 is a sum of the even-numbered filters (2, 4, 6 & 8) only.

## MIDI support

MIDI notes set the pitch and control the gates of the filters.

Whether or not the algorithm responds to MIDI notes, and the range of notes to respond to, can be set from the algorithm's menu (in the same way as illustrated for the SD Multisample algorithm, above).

## Parameters

|       | Name             | Min  | Max | Default | Unit | Description  |
|-------|------------------|------|-----|---------|------|--|
| 1-6   | Attenuverter 1-6 | -200 | 200 | 100     | %    | Applies an attenuverter to the corresponding input. A negative value indicates that the CV will be inverted.                                   |
| 7     | Mode             | 0    | 2   | 0       |      | Selects the filter mode. The options are Resonator, Bandpass or Multiband.   |
| 8     | Gain/Q           | 1    | 100 | 50      | %    | Sets the filter gain (for resonators) or resonance (for bandpass/multiband).   |
| 9     | Dry gain         | -40  | 6   | -3      | dB   | The amount of the dry signal to mix into the outputs. At “-40” there is no dry signal at all i.e. it's actually $-\infty$ dB.                  |
| 10    | Effect gain      | -40  | 6   | -3      | dB   | The amount of the effect (filtered) signal to mix into the outputs. At “-40” there is no effect signal at all i.e. it's actually $-\infty$ dB. |
| 11    | Attack time      | 0    | 127 | 0       |      | The envelope attack time.  |
| 12    | Decay time       | 0    | 127 | 0       |      | The envelope decay time.   |
| 13-20 | Pitch 1-8        | 0    | 127 |         |      | The pitches/frequencies of the eight filters.  |
| 21-28 | Gate 1-8         | 0    | 1   | 0       |      | The gates for the eight filters.   |
| 29-36 | Gain 1-8         | -40  | 6   | 0       | dB   | The gain for the eight filters. “-40” is treated as $-\infty$ dB.  |
| 37-44 | VCA input 1-8    | 0    | 6   | 0       |      | The input to use as a VCA for the filter, or '0' for 'None'.   |

|    | <b>Name</b>       | <b>Min</b> | <b>Max</b> | <b>Default</b> | <b>Unit</b> | <b>Description</b>  |
|----|-------------------|------------|------------|----------------|-------------|---|
| 45 | Spread            | -100       | 100        | 0              | %           | Sets an amount by which to spread out the filters in the stereo field.  |
| 46 | LFO depth         | 0          | 100        | 0              | %           | Sets the depth of an octature LFO modulation of the filter gains.   |
| 47 | LFO rate          | -100       | 100        | 50             |             | Sets the LFO rate.  |
| 48 | CV/Gate control   | 0          | 2          | 0              |             | Sets whether inputs 3 & 4 are used as a CV/gate pair to 'play' the filters as pitched voices. The options are Off, On (filter pitch follows the CV) and Quantized (filter pitch set to the nearest semitone). |
| 49 | Controlled voices | 1          | 8          | 8              |             | Sets the number of filters that will be controlled by MIDI or CV/gate. By reducing this, you can elect to control some filters by MIDI while the rest remain under manual control.                            |
| 50 | Mono input        | 0          | 1          | 0              |             | If '1', only input 1 is used for audio input, and input 2 is freed up for CV mapping.   |

### ***Default mappings***

None.

## 10 – Poly Wavetable

[Videos \(playlist\)](#) 

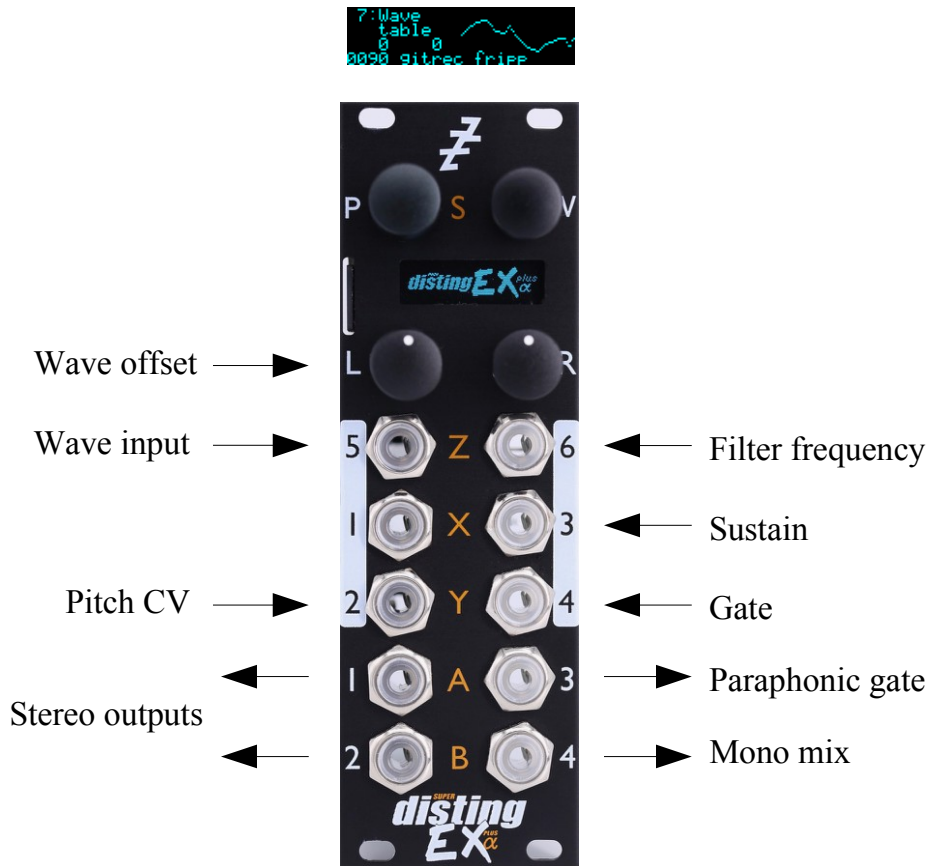

This algorithm is a complete 8 voice polyphonic synthesizer, using wavetable oscillators. Each voice has two envelopes, a filter and an LFO. Delay and chorus effects are also provided.

The algorithm can be played equally well by CV/gate or MIDI. When using CV/gate, the gate inputs are velocity-sensitive.

Automatic chord generation and arpeggiation are provided.

The outputs can be a stereo or mono mix, or each voice can have its own output.

See below for details on how wavetables are installed on the MicroSD card.

The algorithm supports microtonal tunings using Scala or MTS – see 'Scala support', below.

Presets for this algorithm are available to download [here](#)<sup>40</sup>.

### Algorithm-specific display



If the 'Wavetable' parameter is current, the bottom line shows the folder name. If the 'Wave input' or 'Wave offset' parameter is current, the bottom line shows the fractional position in the wavetable (for the loudest voice currently playing – the graphical display of the waveform also reflects this voice).

<sup>40</sup> <https://expert-sleepers.co.uk/distingEXcontent.html>



Note that the waveform may be different per voice if e.g. the 'Wave spread' parameter is used.



For most parameters, the display shows the note numbers being played by the 8 voices, or "--" if a voice is not playing. On each voice is superimposed a vertical bar representing the voice's current envelope level.

## Inputs

The 'Input mode' parameter controls how many of the module's inputs are used as CV/gate inputs. The options are as follows. Remember that holding 'V' shows you what the inputs are being used for.

|                             |   |
|-----------------------------|---|
| <b>No CV/Gate inputs</b>    | Select this if you're playing the module by MIDI or I2C and want the maximum number of CV inputs for parameter mapping. |
| <b>1 CV/Gate pair</b>       | Uses input 2 for pitch and 4 for gate.  |
| <b>2 CV/Gate pairs</b>      | As above plus input 1 for pitch and 3 for gate.   |
| <b>3 CV/Gate pairs</b>      | As above plus input 5 for pitch and 6 for gate.   |
| <b>2 CVs/1 Gate</b>         | Uses inputs 1 & 2 for pitch and 4 for gate.   |
| <b>3 CVs/1 Gate</b>         | Uses inputs 1, 2 & 5 for pitch and 4 for gate.  |
| <b>4 CVs/1 Gate</b>         | Uses inputs 1, 2, 5 & 6 for pitch and 4 for gate.   |
| <b>5 CVs/1 Gate</b>         | Uses inputs 1, 2, 3, 5 & 6 for pitch and 4 for gate.  |
| <b>2x 2 CVs/1 Gate</b>      | Two sets: 1 & 2 (pitch)/4 (gate), 5 & 6 (pitch)/3 (gate).   |
| <b>3 CVs/Gate + CV/Gate</b> | Two sets: 1, 2 & 5 (pitch)/4 (gate), 6 (pitch)/3 (gate).  |

After these options, the same pattern repeats again, but with 'Pressure' instead of 'Gate'. In these modes, the gate inputs effectively become VCA inputs, replacing the volume control from the envelope with direct volume control from the pressure CV. The threshold required to trigger a note (which is set by the 'Gate CV threshold' setting – see below) is reduced by a factor of 16.

## Outputs

If 'Output mode' is 0, 1 or 2:

- Outputs 1 & 2 are the main stereo outputs.
- Output 4 is a mono mix of outputs 1 & 2.
- Output 3 is a 'paraphonic gate'.

If 'Output mode' is 3 ('Per voice'):

- Output 1 carries voices 1 & 5.
- Output 2 carries voices 2 & 6.
- Output 3 carries voices 3 & 7.
- Output 4 carries voices 4 & 8.

There are two choices of what is output as a 'paraphonic gate'. The first outputs a gate as long as any voices are playing; the second outputs a gate as long as any keys are held. This is set via the algorithm's menu:



## MIDI support

This algorithm recognises note on, note off, and pitch bend messages. It also recognises sustain (CC# 64) and All Notes Off (CC# 123 value 0), so these CCs are not available for MIDI mapping.

Notes received over MIDI (and i2c) use the 'Arpeggio 3 mode' and 'Arpeggio 3 range' parameters.

Whether or not the algorithm responds to MIDI notes, and the range of notes to respond to, can be set from the algorithm's menu (in the same way as illustrated for the SD Multisample algorithm, above).

The 'Delay time' parameter can optionally follow MIDI clock. This is also enabled via the menu:



When following MIDI clock, the parameter page shows 'MIDI', as well as the selected clock division and the effective time in milliseconds:



If the MIDI receive channel is set to 'MPE', this algorithm supports per-note pitch bend, and you can optionally override one or both envelopes with the per-note pressure or expression CC (#74). This is done via the algorithm's menu:

## Video



## All notes off

If you encounter stuck notes or other issues, an 'All notes off' function is available from the algorithm's menu.

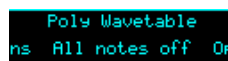

## Parameters

|     | Name             | Min  | Max | Default | Unit | Description  |
|-----|------------------|------|-----|---------|------|--|
| 1-6 | Attenuverter 1-6 | -200 | 200 | 100     | %    | Applies an attenuverter to the corresponding input. A negative value indicates that the CV will be inverted. |
| 7   | Wavetable        | 0    | 999 | 0       |      | Chooses the wavetable from those installed on the MicroSD card.  |
| 8   | Wave offset      | -100 | 100 | 0       |      | An offset for the wavetable position, added to that set from the wave input.                                 |
| 9   | Wave spread      | -100 | 100 | 0       |      | An amount by which to spread out the per-voice wavetable positions.  |
| 10  | Coarse tune      | -60  | 60  | 0       |      | Transposes the whole instrument in semitones.  |

|    | <b>Name</b>     | <b>Min</b> | <b>Max</b> | <b>Default</b> | <b>Unit</b> | <b>Description</b>   |
|----|-----------------|------------|------------|----------------|-------------|--|
| 11 | Fine tune       | -100       | 100        | 0              | cents       | Tunes the whole instrument in cents.   |
| 12 | Attack time     | 0          | 127        | 20             |             | Envelope 1 attack time. Range 1ms-15s.   |
| 13 | Decay time      | 0          | 127        | 60             |             | Envelope 1 decay time. Range 20ms-15s.   |
| 14 | Sustain level   | 0          | 127        | 80             |             | Envelope 1 sustain level.  |
| 15 | Release time    | 0          | 127        | 60             |             | Envelope 1 release time. Range 10ms-30s.                                       |
| 16 | Attack shape    | 0          | 127        | 64             |             | Envelope 1 attack shape.<br>'0' is highly exponential; '127' is almost linear. |
| 17 | Decay shape     | 0          | 127        | 64             |             | Envelope 1 decay & release shape.  |
| 18 | Attack time 2   | 0          | 127        | 60             |             | Envelope 2 attack time. Range 1ms-15s.   |
| 19 | Decay time 2    | 0          | 127        | 70             |             | Envelope 2 decay time. Range 20ms-15s.   |
| 20 | Sustain level 2 | -127       | 127        | 64             |             | Envelope 2 sustain level.<br>Note that this can go negative.                   |
| 21 | Release time 2  | 0          | 127        | 50             |             | Envelope 2 release time. Range 10ms-30s.                                       |
| 22 | Attack shape 2  | 0          | 127        | 64             |             | Envelope 2 attack shape.   |
| 23 | Decay shape 2   | 0          | 127        | 64             |             | Envelope 2 decay & release shape.  |
| 24 | Filter type     | 0          | 3          | 0              |             | The filter type; 'Off', 'Lowpass', 'Bandpass' or 'Highpass'.                   |
| 25 | Filter freq     | 0          | 127        | 64             |             | The filter frequency, specified as a MIDI note number.                         |
| 26 | Filter Q        | 0          | 100        | 50             |             | The filter resonance.  |
| 27 | Veloc -> volume | 0          | 100        | 100            | %           | The amount by which the note velocity affects the note volume.                 |
| 28 | Veloc -> wave   | -100       | 100        | 0              | %           | The amount by which the note velocity affects the wavetable position.          |
| 29 | Veloc -> filter | -127       | 127        | 0              |             | The amount by which the note velocity affects the filter frequency.            |
| 30 | Pitch -> wave   | -100       | 100        | 0              | %           | The amount by which the note pitch affects the wavetable position.             |
| 31 | Pitch -> filter | -100       | 100        | 0              | %           | The amount by which the note pitch affects the filter frequency.               |
| 32 | Env -> wave     | -100       | 100        | 0              | %           | The amount by which envelope 1 affects the wavetable position.                 |
| 33 | Env -> filter   | -127       | 127        | 0              |             | The amount by which envelope 1 affects the filter frequency.                   |
| 34 | Env 2 -> wave   | -100       | 100        | 0              | %           | The amount by which envelope 2 affects the wavetable position.                 |
| 35 | Env 2 -> filter | -127       | 127        | 0              |             | The amount by which envelope 2 affects the filter frequency.                   |

|       | <b>Name</b>        | <b>Min</b> | <b>Max</b> | <b>Default</b> | <b>Unit</b> | <b>Description</b>   |
|-------|--------------------|------------|------------|----------------|-------------|--|
| 36    | Env 2 -> pitch     | -120       | 120        | 0              |             | The amount by which envelope 2 affects the note pitch (in units of 1/10 <sup>th</sup> semitones).  |
| 37    | LFO -> wave        | -100       | 100        | 0              | %           | The amount by which the LFO affects the wavetable position.  |
| 38    | LFO -> filter      | -127       | 127        | 0              |             | The amount by which the LFO affects the filter frequency.  |
| 39    | LFO -> pitch       | -120       | 120        | 0              |             | The amount by which the LFO affects the note pitch (in units of 1/10 <sup>th</sup> semitones).   |
| 40    | LFO speed          | -100       | 100        | 90             |             | The LFO speed. Range 0.01Hz-10Hz.  |
| 41    | Gain               | -40        | 24         | 0              | dB          | Applies an overall output gain.  |
| 42    | Sustain            | 0          | 1          | 0              |             | Activates sustain (notes remain playing when the gate goes low).   |
| 43    | Bend range         | 0          | 48         | 2              |             | The pitch bend range, in semitones. Applies both to MIDI pitch bend, and to CV pitch bend, in which case a CV of $\pm 5V$ maps to the chosen bend range.   |
| 44    | Chord enable       | 0          | 7          | 0              |             | Enables the chord generator function. The chord generator can be on or off globally, or per gate (MIDI/I2C counts as gate 3).  |
| 45    | Chord key          | -12        | 12         | 0              |             | The key of the chord generator. “0” is C, “1” is C $\sharp$ /D $\flat$ etc.  |
| 46    | Chord scale        | 0          | 7          | 0              |             | The scale of the chord generator. See below for the options.   |
| 47    | Chord shape        | 0          | 13         | 0              |             | The shape of the chord generator. See below for the options.   |
| 48    | Chord inversion    | 0          | 3          | 0              |             | The chord inversion. For example the first inversion takes the first note of the chord and moves it an octave up, so the lowest note in the chord is now the second (e.g. C E G becomes E G C). See e.g. <a href="https://en.wikipedia.org/wiki/Inversion_(music)#Inversions">here</a> <sup>41</sup> for a fuller explanation of inversions. |
| 49-51 | Arpeggio 1-3 mode  | 0          | 14         | 0              |             | The arpeggiator mode for each CV/gate input pair. See below for the options.   |
| 52-54 | Arpeggio 1-3 range | 1          | 3          | 1              |             | When set to 1, the arpeggio is simply the notes formed by the chord. When set to 2 or 3, a copy of the chord is appended to the pattern, one or two octaves higher, creating a longer pattern that spans multiple octaves.   |
| 55    | Scala/MTS          |            |            | 0              |             | Sets the Scala scale or MTS tuning to use. See above.  |
| 56    | Scala KBM          |            |            | 0              |             | Sets the Scala keyboard map to use. See above.   |

41 [https://en.wikipedia.org/wiki/Inversion\\_\(music\)#Inversions](https://en.wikipedia.org/wiki/Inversion_(music)#Inversions)

|    | Name             | Min  | Max   | Default | Unit  | Description  |
|----|------------------|------|-------|---------|-------|--|
| 57 | Chorus mode      | 0    | 2     | 0       |       | Engages the chorus effect, or '0' for 'off'. <sup>42</sup>   |
| 58 | Delay mode       | 0    | 2     | 0       |       | The type of delay effect: 'Off', 'Stereo' or 'Ping-pong'.  |
| 59 | Delay level      | -40  | 0     | -3      | dB    | The level of the delay effect. '-40' is treated as $-\infty$ dB.   |
| 60 | Delay time       | 1    | 10000 | 500     | ms    | The delay time, in milliseconds.   |
|    | <i>or</i>        | 1    | 18    | 5       |       | The delay time, if following MIDI clock.   |
| 61 | Delay feedback   | 0    | 100   | 50      | %     | The delay feedback.  |
| 62 | Unison           | 1    | 8     | 1       |       | The number of voices to play simultaneously for each note triggered.   |
| 63 | Unison detune    | 0    | 100   | 10      | cents | The detune amount when Unison is active.   |
| 64 | Output spread    | -100 | 100   | 0       | %     | The amount of output spread, if the selected output mode uses spread.  |
| 65 | Output mode      | 0    | 3     | 0       |       | The output mode – see below for details.   |
| 66 | Input mode       | 0    | 18    | 1       |       | Sets how the inputs are used for CV/gate control. See above.   |
| 67 | Sustain mode     | 0    | 1     | 0       |       | Sets the behaviour of the sustain function. The options are “Synth” (sustained notes cannot be retriggered) and “Piano” (sustained notes can be retriggered).  |
| 68 | MIDI vel curve   | 0    | 3     | 0       |       | Selects a velocity curve applied to incoming MIDI notes.   |
| 69 | Wave input       | 0    | 6     | 5       |       | Which input to use to control the position in the wavetable, or '0' for 'None'.  |
| 70 | Pitch bend input | 0    | 6     | 0       |       | The pitch bend input, or “0” for none.   |
| 71 | Arp reset input  | 0    | 6     | 0       |       | The input to use as the arpeggiator reset, or “0” for none. A trigger pulse into this input will reset the arpeggiator back to step 1.   |
| 72 | Max voices       | 1    | 8     | 8       |       | Sets the maximum number of simultaneous voices.  |
| 73 | LFO retrigger    | 0    | 2     | 0       |       | Sets whether the LFOs are retriggered at note on. The options are 'Poly' (each voice's LFO triggers independently), 'Mono' (all LFOs are retriggered when the first note is played), or 'Off' (LFOs are free-running). |

<sup>42</sup> The chorus effect is unapologetically modelled on that of the classic Juno-6 polysynth, based on measurements of the author's own unit.

|    | <b>Name</b>     | <b>Min</b> | <b>Max</b> | <b>Default</b> | <b>Unit</b> | <b>Description</b>   |
|----|-----------------|------------|------------|----------------|-------------|--|
| 74 | LFO spread      | 0          | 90         | 0              |             | Sets the phase to which LFOs are retriggered. The value, in degrees <sup>43</sup> , is multiplied by the voice number to give the initial LFO phase. When retrigger is off, this sets the phase relationship between the free-running LFOs.          |
| 75 | Gate offset     | 0          | 496        | 0              |             | Offsets (delays) the gate inputs relative to the pitch inputs. This is useful to allow pitch CVs to settle before they are sampled on the rising gate, and also to cope with modules which output both a pitch and gate but change their gate first. |
| 76 | Trigger mode    | 0          | 2          | 0              |             | Sets the note triggering mode. See below.  |
| 77 | Break time      | 0          | 1000       | 0              | ms          | The 'break' time for chords, or "0" for off. See above.  |
| 78 | Break direction | 0          | 2          | 0              |             | The 'break' direction. See above.  |

### **Default mappings**

Input 3 is mapped to 'Sustain'.

Input 5 is mapped to 'Wave input'.

Input 6 is mapped to 'Filter freq'.

The 'L' knob is mapped to 'Wave offset'.

### **Output modes**

The available values for the 'Output mode' parameter are as follows:

| <b>Value</b> | <b>Name</b>       | <b>Description</b>  |
|--------------|-------------------|---|
| 0            | Spread by voice   | Voices are spread across the stereo field from left to right.   |
| 1            | Spread by voice 2 | Voices are spread across the stereo field in an alternating left/right manner, by a small amount for voices 1/2, increasing up to voices 7/8. |
| 2            | Spread by pitch   | Voices are spread across the stereo field according to their pitch, with note 48 at the centre.   |
| 3            | Per voice         | Each voice comes out of one output only, as described above.  |

### **Tap tempo**

When the 'Delay time' parameter is current, pressing the 'R' button acts as a 'tap tempo' function to set the delay time (instead of resetting the parameter to its default value).

### **Chords and arpeggiators**

The various chord and arpeggiator parameters are exactly the same as those in the SD Multisample

---

<sup>43</sup> 360° per LFO cycle.

algorithm. Please refer to the documentation of that algorithm, above.

### ***Scala and MTS support***

This algorithm's Scala and MTS (MIDI Tuning Standard) parameters are also the same as those for the SD Multisample algorithm – see above. Unlike the SD Multisample algorithm however, this algorithm updates its tuning on the fly as you switch between scales/keyboard mappings.

### ***Trigger mode***

[Video](#) 

The 'Trigger mode' parameter controls how notes are triggered. The options are as follows:

|           |   |
|-----------|---|
| Gated     | Normal operation. Notes start at gate on and are released at gate off.  |
| Drone     | Notes play continuously.  |
| Triggered | Notes start at gate on; envelopes proceed through one full cycle of attack, decay and release. Gate off is ignored. |

# 11 – Granulator

[Videos \(playlist\)](#) 

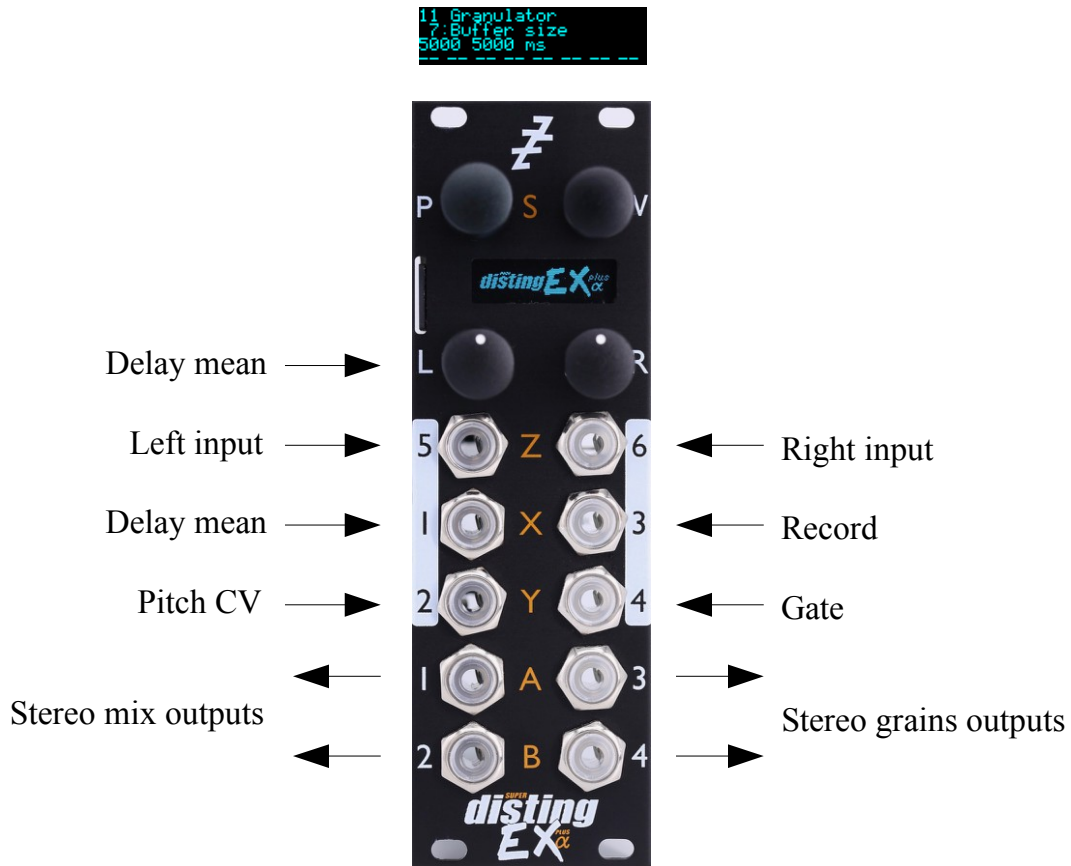

This algorithm implements a granular synthesis<sup>44</sup> engine, taking as its source material either live audio input or audio loaded from the SD card. Live audio can be recorded into a buffer (maximum size about 31 seconds) or streamed continuously.

Granular synthesis works by playing many short snippets of sound, or 'grains', typically of the order of 100ms in length. Often various properties of the grains (e.g. their timing, length, pitch, stereo panning etc.) are randomised to some extent.

In this algorithm, the creation ('spawning') of grains is controlled by 'notes'. Notes control when grain clouds begin and end, and affect other features e.g. the grain pitch.

Notes can be played into the engine via CV/gate pairs or MIDI/I2C (exactly as for the module's other synth engines e.g. the Poly Wavetable). The algorithm also offers three 'drone' voices, which can simply be enabled via the usual parameter interface. When using the algorithm as an audio processing effect you're likely to just enable one or more of these drones and leave them on while manipulating other grain parameters.

As in the other algorithms, you can choose from zero to 3 CV/gate pairs to play notes. Selecting less CV/gate pairs will allow more inputs to be mapped for CV control of parameters. (The default is one CV/gate pair.)

The algorithm does nothing until you've recorded some audio into it or loaded some audio from the SD card.

<sup>44</sup> Essential reading on granular synthesis includes *Microsound* by Curtis Roads, <https://mitpress.mit.edu/books/microsound>



Two suggested ways of getting started:

- 1) Connect an audio input, enable Record and enable Drone 1.
- 2) Connect CV/gate or MIDI, load a sample from the card, and play.

## Effects and routing

The algorithm includes a standard delay/echo effect and a reverb, which can be applied to just the granulator or to the mix of the granulator and the dry signal, according to the 'Effects routing' parameter. Other flavours of delay/echo can be achieved with the input feedback, which effectively applies an echo on the input signal, and the 'main feedback', which echoes the granulator output to the buffer input.

The signal flow of the granulator section looks like this:

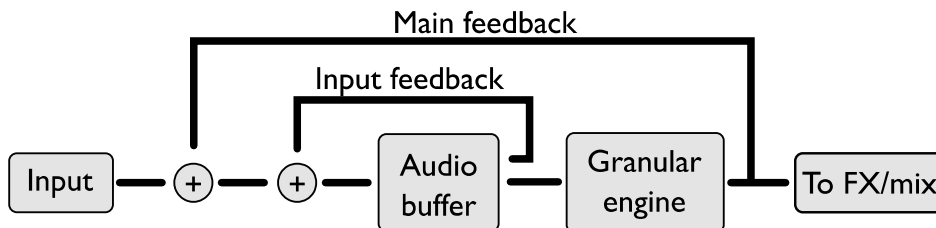

The three different effects routing options are:

Delay->Reverb->Mix

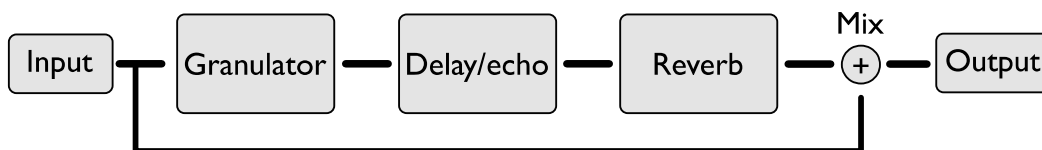

Delay->Mix->Reverb

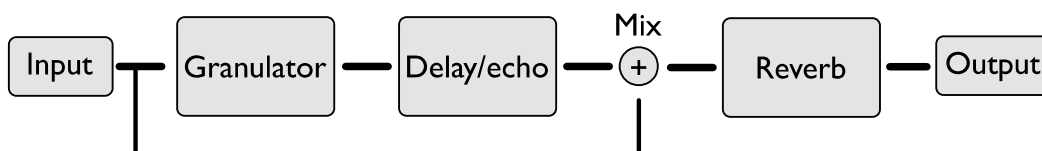

Mix->Delay->Reverb

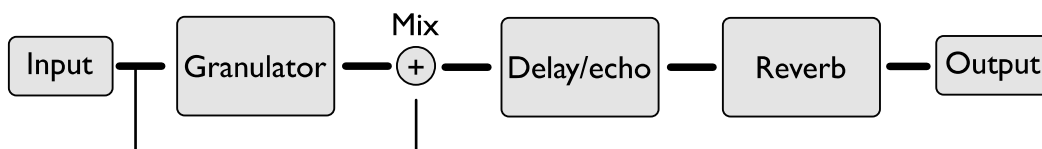

## Algorithm-specific display

The algorithm has a special display mode which shows an overview of the audio waveform in the buffer, and the positions of the various grains. This is accessed by double-clicking the 'V' knob.



The two dotted vertical lines indicate the range of the buffer that will be played (at normal pitch), as set by the 'Delay mean' and 'Size mean' parameters. The two numbers at the bottom are the delay mean and buffer size, in milliseconds. The number at the top left is the current number of active

grains. At the top right is an indicator of whether 'Record' is active.

You can optionally set this mode to appear automatically when the interface is otherwise idle. Do this via the 'Auto visuals' option under the algorithm's menu. The value is a time in seconds, or zero to disable this feature.



If you double-click 'V' to exit the visuals display mode, 'Auto visuals' will not apply until you double-click again to enter the mode.

Another option, 'MIDI leaves visuals', causes the display to automatically revert to the normal display mode when a parameter change is received via MIDI.



The options are 'Off', 'All' and 'Most'. 'Most' remains in the visuals mode if the MIDI parameter change affects 'Buffer size', 'Delay mean' or 'Size mean'.

## Outputs

Outputs 1 & 2 present a mix of the input signal and the granulator output with effects applied.

Outputs 3 & 4 present just the granulator output.

## MIDI support

This algorithm recognises note on, note off, and pitch bend messages. It also recognises sustain (CC# 64) and All Notes Off (CC# 123 value 0), so these CCs are not available for MIDI mapping.

Whether or not the algorithm responds to MIDI notes, and the range of notes to respond to, can be set from the algorithm's menu (in the same way as illustrated for the SD Multisample algorithm, above).

The 'Out delay time' parameter can optionally follow MIDI clock. This is also enabled via the menu:



When following MIDI clock, the parameter page shows 'MIDI', as well as the selected clock division and the effective time in milliseconds:



## Parameters

|     | Name             | Min  | Max   | Default | Unit | Description  |
|-----|------------------|------|-------|---------|------|--|
| 1-6 | Attenuverter 1-6 | -200 | 200   | 100     | %    | Applies an attenuverter to the corresponding input. A negative value indicates that the CV will be inverted. |
| 7   | Buffer size      | 100  | 31250 | 5000    | ms   | The audio buffer size in milliseconds.   |
| 8   | Input gain       | -34  | 12    | 0       | dB   | Gain applied to the audio being recorded (does not affect the dry signal). '-34' is treated as $-\infty$ dB. |

|    | <b>Name</b>     | <b>Min</b> | <b>Max</b> | <b>Default</b> | <b>Unit</b> | <b>Description</b>   |
|----|-----------------|------------|------------|----------------|-------------|--|
| 9  | Dry gain        | -40        | 6          | 0              | dB          | Level of the input signal in the output mix. '-40' is treated as $-\infty$ dB.   |
| 10 | Granulator gain | -40        | 6          | 0              | dB          | Level of the granulator signal in the output mix. '-40' is treated as $-\infty$ dB.  |
| 11 | Record          | 0          | 1          | 0              |             | Enables recording into the buffer.   |
| 12 | Spawn mode      | 0          | 3          | 0              |             | How grains are spawned. See below.   |
| 13 | Rate mean       | 1          | 1000       | 5              | ms          | The average time between new grains being spawned.   |
| 14 | Rate spread     | 0          | 200        | 10             | %           | The amount of variation in the spawn rate, expressed as a percentage of 'Rate mean'.   |
| 15 | Size mean       | 0          | 1000       | 100            | ms          | The average grain size. '0' has a special meaning – see below.   |
| 16 | Size spread     | 0          | 200        | 10             | %           | The amount of variation in grain size, expressed as a percentage of 'Size mean'.   |
| 17 | Pitch mean      | -24        | 24         | 0              | ST          | The average grain pitch shift (in semitones). This is added to the pitch shift determined by the note's pitch CV.  |
| 18 | Pitch spread    | 0          | 1200       | 0              | cents       | The amount of variation in grain pitch shift.  |
| 19 | Pan mean        | -100       | 100        | 0              | %           | The average grain pan position.  |
| 20 | Pan spread      | 0          | 100        | 10             | %           | The amount of variation in grain pan.  |
| 21 | Delay mean      | 0          | 100        | 50             | %           | The average grain delay (equivalently, the position in the audio buffer), expressed as a percentage of the buffer size.  |
|    | <i>or</i>       | 0          | 5000       | 2500           | ms          | The average grain delay (equivalently, the position in the audio buffer) in milliseconds.  |
| 22 | Delay spread    | 0          | 100        | 5              | %           | The amount of variation in grain delay, expressed as a percentage of the buffer size.  |
|    | <i>or</i>       | 0          | 5000       | 250            | ms          | The amount of variation in grain delay, in milliseconds.   |
| 23 | Shape           | 0          | 5          | 0              |             | The grain envelope/window shape. See below.  |
| 24 | Opacity         | 0          | 100        | 100            | %           | The 'opacity' of a note, which is the percentage of grains that would normally make up the note that actually sound.   |
| 25 | LFO depth       | -100       | 100        | 0              | %           | The depth of the LFO that affects the grain delay, expressed as a percentage of the buffer size.   |
| 26 | LFO speed       | 0          | 255        | 196            |             | The speed of the grain delay LFO. This is scaled relative to the buffer size – at the default value of 196 the LFO will cause the 'play head' (to use a tape metaphor) to advance at 1x speed. |

|       | <b>Name</b>       | <b>Min</b> | <b>Max</b> | <b>Default</b> | <b>Unit</b> | <b>Description</b>   |
|-------|-------------------|------------|------------|----------------|-------------|--|
| 27    | Input feedback    | 0          | 100        | 0              | %           | The amount of feedback to apply around the audio buffer itself when recording (resulting in an echo effect on the input material, with a delay time equal to the buffer size).   |
| 28    | Main feedback     | 0          | 100        | 0              | %           | The amount of the granulator output to feed back into the audio buffer when recording.   |
| 29    | Attack time       | 0          | 127        | 64             |             | Envelope attack time. Range 100ms-30s.   |
| 30    | Release time      | 0          | 127        | 64             |             | Envelope release time. Range 100ms-30s.  |
| 31    | Env -> opacity    | 0          | 100        | 0              | %           | The amount by which the note envelope affects the note opacity.  |
| 32    | Env -> level      | 0          | 100        | 100            | %           | The amount by which the note envelope affects the note level (volume).   |
| 33    | Veloc -> level    | 0          | 100        | 100            | %           | The amount by which the note velocity affects the note level (volume).   |
| 34    | Veloc -> delay    | -100       | 100        | 0              | %           | The amount by which the note velocity affects the grain delay.   |
| 35    | Pitch -> pitch    | -100       | 100        | 100            | %           | The amount by which the note pitch affects the grain pitch. Commonly this will either be 100% (normal pitch tracking) or 0% (the incoming pitch doesn't affect the grain pitch at all, but may still affect e.g. the grain delay). |
| 36    | Pitch -> delay    | -100       | 100        | 0              | %           | The amount by which the note pitch affects the grain delay.  |
| 37    | Normalize         | 0          | 1          | 1              |             | If enabled, the overall volume of the grain cloud is lowered according to how many grains are active.  |
| 38    | Natural pitch     | 0          | 127        | 48             | ST          | Sets the natural pitch of the audio i.e. the MIDI note number that will play back the audio at the same pitch at which it was recorded.  |
| 39    | Drone 1 pitch     | 0          | 127        | 48             | ST          | The MIDI note number for drone 1.  |
| 40    | Drone 2 pitch     | 0          | 127        | 36             | ST          | The MIDI note number for drone 2.  |
| 41    | Drone 3 pitch     | 0          | 127        | 60             | ST          | The MIDI note number for drone 3.  |
| 42-44 | Drone 1-3 enable  | 0          | 1          | 0              |             | Enables (gates) for the three drones.  |
| 45-47 | Drone 1-3 opacity | 0          | 100        | 100            | %           | The opacity of the three drones.   |
| 48-50 | Drone 1-3 level   | -40        | 6          | 0              | dB          | The level (volume) of the three drones.  |
| 51    | Out delay mode    | 0          | 2          | 0              |             | The type of the output delay effect: 'Off', 'Stereo' or 'Ping-pong'.   |

|    | <b>Name</b>        | <b>Min</b> | <b>Max</b> | <b>Default</b> | <b>Unit</b> | <b>Description</b>  |
|----|--------------------|------------|------------|----------------|-------------|---|
| 52 | Out delay level    | -40        | 0          | -3             | dB          | The level of the output delay effect. '-40' is treated as $-\infty$ dB.   |
| 53 | Out delay time     | 1          | 2730       | 500            | ms          | The output delay time, in milliseconds.   |
|    | <i>or</i>          | 1          | 18         | 5              |             | The output delay time, if following MIDI clock.   |
| 54 | Out delay feedback | 0          | 100        | 50             | %           | The output delay feedback.  |
| 55 | Reverb mix         | 0          | 100        | 50             | %           | A wet/dry control for the reverb effect.  |
| 56 | Reverb time        | 400        | 30000      | 1700           | ms          | The reverb time.  |
| 57 | Grain limit        | 1          | 40         | 40             |             | Imposes an arbitrary limit on the number of simultaneous grains.  |
| 58 | Bend range         | 0          | 48         | 2              | ST          | The MIDI pitch bend range.  |
| 59 | Reverse            | 0          | 100        | 0              | %           | Sets the probability that a grain will be played backwards.   |
| 60 | Pitch quantize     | 0          | 5          | 0              |             | If set, quantizes the random pitch deviation (the sum of the 'Pitch mean' and 'Pitch spread') to musical intervals. See below.                                |
| 61 | LFO shape          | 0          | 2          | 0              |             | Sets the LFO shape. The options are Triangle, Ramp up, and Ramp down.   |
| 62 | Record fade        | 0          | 1000       | 5              | ms          | The duration of the fade applied when starting and stopping recording, to avoid clicks.   |
| 63 |                    |            |            |                |             |   |
| 64 |                    |            |            |                |             |   |
| 65 | Input mode         | 0          | 3          | 1              |             | Sets how many input CV/gate pairs the algorithm uses. "1" uses inputs 2/4; "2" adds inputs 1/3; "3" adds inputs 5/6.  |
| 66 | Mono input         | 0          | 1          | 0              |             | If '0', inputs 5 & 6 are used as a stereo input. If '1', only input 5 is used, as a mono input (leaving input 6 free for parameter mapping).                  |
| 67 | Sustain mode       | 0          | 1          | 0              |             | Sets the behaviour of the sustain function. The options are "Synth" (sustained notes cannot be retriggered) and "Piano" (sustained notes can be retriggered). |
| 68 | Delay mean input   | 0          | 6          | 1              |             | The CV input to use to control the grain delay. A CV of 5V corresponds to 100% of the buffer size.  |
| 69 | Effects routing    | 0          | 2          | 0              |             | Controls where the effects and dry/wet mix appear in the signal chain. See above.   |
| 70 | Reverb model       | 0          | 3          | 1              |             | Chooses the reverb model.   |

|    | <b>Name</b>       | <b>Min</b> | <b>Max</b> | <b>Default</b> | <b>Unit</b> | <b>Description</b>   |
|----|-------------------|------------|------------|----------------|-------------|--|
| 71 | Reverb size       | 1          | 100        | 100            | %           | Sets the size of the reverb space – mainly affects the times of the early reflections. |
| 72 | Reverb high damp  | 0          | 100        | 60             |             | Sets the amount of high frequency damping in the reverb tail.                          |
| 73 | Reverb mod speed  | 1          | 500        | 250            | 0.01 Hz     | Sets the speed of reverb modulation.   |
| 74 | Reverb mod depth  | 0          | 100        | 25             |             | Sets the depth of reverb modulation.   |
| 75 | Reverb early gain | -40        | 6          | -12            | dB          | Sets the output level of the early reflections.  |
| 76 | Reverb diff gain  | -40        | 6          | -6             | dB          | Sets the output level of the diffuse reflections.                                      |
| 77 | Delay unit        | 0          | 1          | 0              |             | Determines whether the Delay mean and spread parameters work in terms of % or ms.      |

### ***Default mappings***

Input 1 is the 'Delay mean input'.

Input 3 is mapped to 'Record'.

The 'L' knob is mapped to 'Delay mean'.

The 'L' button is mapped to 'Record'.

### ***Spawn mode***

The spawn mode parameter controls the algorithm by which new grains are spawned. The options are:

- **Stochastic** (the default): grains are spawned randomly according to the 'Rate mean' and 'Rate spread' parameters.
- **Mid-grain**: a new grain is spawned at the middle point of the current grain. This is intended to be used with 'Size spread' at zero and with 'Shape' as 'Equal power', resulting in smooth crossfade looping, but you are of course free to use it creatively as you wish.

Each of these options also has a 'fixed' variant ('Stochastic (fixed)' and 'Mid-grain (fixed)'). This behaves identically unless recording is active. The difference relates to how the grain positions are calculated, using the delay mean and spread parameters.

In the non-fixed modes, the grain positions are relative to the current audio buffer write position – effectively, relative to 'now'.

In the fixed modes, the grains positions are relative to the buffer write position at the time the note started. Conceptually, the grains are fixed relative to the audio, and indeed if you watch the grains spawn in the visual display you'll see them travelling across the screen as the audio scrolls.

In practice this means that in the 'fixed' modes, notes tend to have a fixed timbre for their duration, whereas in the non-'fixed' modes the timbre will vary as the audio scrolls past under the note position.

### ***Size mean '0'***

If the 'Size mean' parameter is set to zero, the grain size is calculated from the note pitch, and set to be the duration of one cycle of an oscillation that corresponds to the given pitch. This is particularly effective in conjunction with the 'Mid-grain (fixed)' spawn mode.



### ***Pitch quantize***

The available values for the Pitch quantize parameter are as follows.

| <b>Value</b> | <b>Description</b> |
|--------------|--------------------|
| 0            | Off                |
| 1            | Octaves            |
| 2            | Fourths            |
| 3            | Fifths             |
| 4            | Major Triad        |
| 5            | Minor Triad        |

## Shape

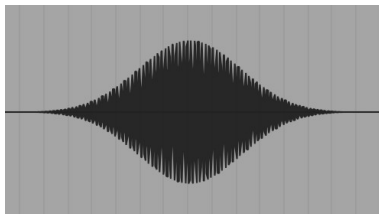
The 'Shape' parameter sets the volume envelope (also called 'window' in some of the literature) of the grains. The options are as follows.

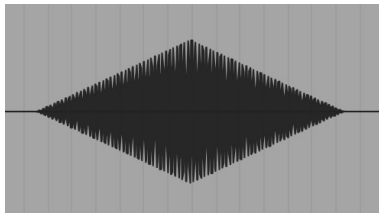
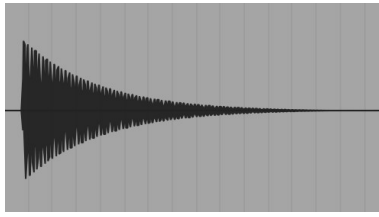
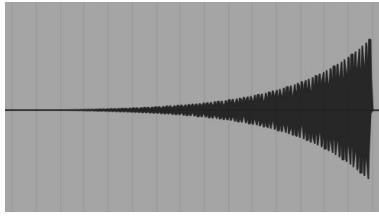
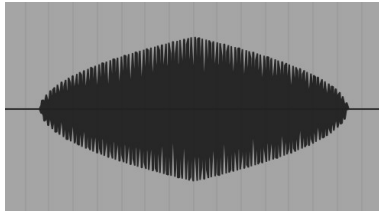
| Value | Name        | Description                                 | Image   |
|-------|-------------|---|---|
| 0     | Gaussian    | A gaussian bell curve.                      |    |
| 1     | Tukey       | A rectangle convolved with a raised cosine. |    |
| 2     | Triangle    | A simple triangle shape.                    |   |
| 3     | Expodec     | A decaying exponential curve.               |  |
| 4     | Rexpodec    | A rising exponential curve.                 |  |
| 5     | Equal power | Back-to-back square root curves.            |  |



## Saving/loading WAV files

The Granulator can load WAV files from the MicroSD card into the audio buffer, and can save the buffer contents as a WAV file.

Files are saved and loaded from the Granulator's own menu, which is accessed by pressing 'P' in the usual way:

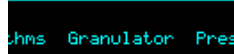

```
hms Granulator Pres
```

## Loading a WAV file

From the Granulator menu, select 'Load' and then either 'Load WAV' or 'Load WAV (raw)'.

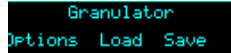

```
Granulator  
Options Load Save
```

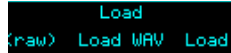

```
Load  
(raw) Load WAV Load
```

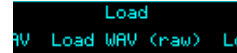

```
Load  
WAV Load WAV (raw) Load
```

You can then navigate to the WAV file that you want to load.

The difference between the two options is that the first will, if necessary, perform sample rate conversion to maintain the audio's pitch. The second option simply loads frames from the source file 1:1 into the buffer.

If the file is longer than the maximum buffer size, the rest of the file is ignored.

If the file is stereo, only the left channel is loaded.

The buffer size parameter is automatically set to match the length of the loaded file.

## Saving a WAV file

From the Granulator menu, select 'Save':

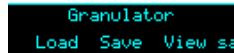

```
Granulator  
Load Save View saved path
```

The contents of the audio buffer will be saved to the MicroSD card as a WAV file, into a folder named "!GRANUL8". A unique filename is automatically generated, starting with "GRAN" and then a number.

The filename is displayed when saving is complete:



```
Saved to  
GRAN0006
```

## Viewing the WAV path

From the Granulator menu, selecting 'View saved path'

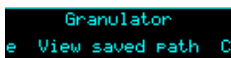

```
Granulator  
e View saved path C
```

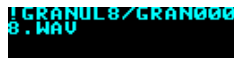

```
!GRANUL8/GRAN0006  
8.WAV
```



```
LABS Soft Pno -  
PedOn [MS1]/PedOn  
-A-1.wav
```



```
<none>
```

will show the path on the SD card of the last WAV file loaded or saved by the algorithm, or "<none>" if no file is associated with the algorithm. Clearing the buffer and changing the buffer size both clear the stored WAV path.

If a preset is stored with a saved path, the WAV file will be reloaded automatically when the preset is loaded.

## ***Clearing the audio buffer***

The 'Clear buffer' menu item under the Granulator menu erases all audio in the buffer.

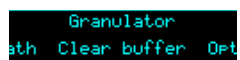
A screenshot of a menu item. The text is displayed in a monospaced font on a black background. The first line reads 'Granulator' and the second line reads 'ath Clear buffer Opt'.

```
Granulator  
ath Clear buffer Opt
```

## 12 – Multi FX

[Videos \(playlist\)](#) 



This algorithm is a flexible stereo multi-fx processor, offering simultaneous EQ, pitch effects, delay and reverb<sup>45</sup>. It also supports a “variable sample rate” feature, allowing you to change (under CV control if desired) the DSP's internal sample rate, which has a number of creative applications.

### Routing

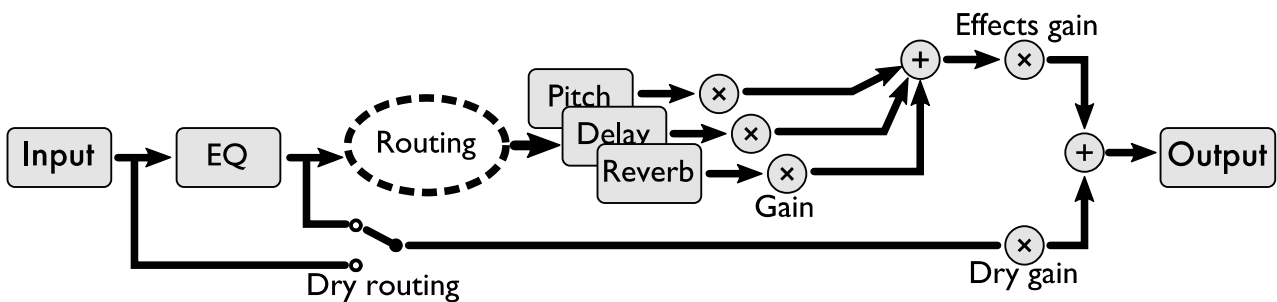

The routing between effects sections is quite flexible, allowing them to be chained in different orders, or to work in parallel.

In stereo operation, inputs 1 & 2 are the audio inputs. For mono operation, use input 1 and set the 'Mono input' parameter to '1'.

<sup>45</sup> Eagle-eyed users may notice some similarities of design to a certain “simultaneous digital effects processor” from the late '80s.

The EQ section always comes first – it processes the 'dry' input. You have an option as to whether the pre- or post-EQ signal is considered to be the dry signal for purposes of the output mix (see the 'Dry routing' parameter).

Each of the pitch, delay and reverb sections takes as input a mix of two signals, which you can choose freely from the pre- or post-EQ dry signals, or the outputs of the other sections.

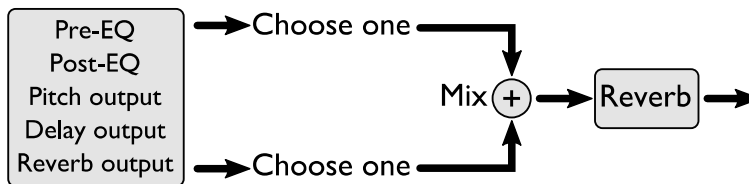

The output of the algorithm is a mix of the dry signal and the three effect sections.

It should be apparent that this flexibility also allows you to set up feedback loops. In some cases this can be useful (especially if a delay is involved); other times it will simply create howling feedback. Route with care.

### Algorithm-specific display

The bottom line of the display indicates which of the major function blocks the current parameter belongs to:

```
12 Multi FX
11: Dry gain
  0      0 dB
  OUTPUT MIX
```

```
13 Multi FX
18: EQ 1 frequency
  26    26 102Hz
  3 BAND EQ
```

```
12 Multi FX
27: Pitch input 2
  3    3 Delay
  PITCH - Chorus
```

```
12 Multi FX
51: Reverb model
  1    1 Hall 2
  REVERB
```

The top line shows warnings if the outputs clip:

```
CLIPPING!
15: Reverb gain
  6      6 dB
  OUTPUT MIX
```

### EQ

The EQ section offers three bands of EQ (in series).

EQ 1 offers 6dB/octave high-pass, 12dB/octave high-pass, or low shelving EQ.

EQ 2 is a peak/notch band with adjustable Q.

EQ 3 offers 6dB/octave low-pass, 12dB/octave low-pass, or high shelving EQ.

### Pitch Effects

The pitch effects section provides one of three effects: chorus/flange, phaser, or pitch shift.

For a chorus effect, select a longish 'Chorus delay' with a low 'Chorus depth' and low 'Pitch feedback'. For a flanger, you want a short 'Chorus delay' and a high 'Chorus depth', and add feedback to taste.

The 'spread' control applies to the chorus and phaser effects, and sets the phase difference in the LFOs for the left and right channel. When at the default setting of 180 you get the 'stereo chorus' effect provided on certain classic synths to generate a stereo output from an essentially mono source.

### Delay

The delay section offers mono, stereo and ping-pong delay effects. In fact, 'mono' is a misnomer

since the signal path is still stereo – but the delay is set by a single parameter for both channels, as compared to 'stereo' mode where each channel has independent delays.

Each mode comes in two flavours – 'fade' and 'slew'. The difference is in how the delays respond to changes in delay time. The 'fade' version crossfades between the two times; the 'slew' version gives a dynamic effect like speeding up or slowing down tape.

The delay times can be set manually, via MIDI, or via a clock input.

## **Reverb**

The reverb section offers a classic algorithmic reverb effect. 'Reverb time' is the primary control, and is by default controlled by CV on input 5.

Modulation speed and depth parameters control a chorus-like effect applied within the reverb echoes.

## **Variable Sample Rate**

By default the algorithm runs at 96kHz, but you can change this (downwards) using the 'VSR' parameters and CV input. This simulates in software the popular effects achievable in hardware from devices where the actual physical clock speed of the DSP chip can be controlled.

Modulating the sample rate modulates the effective pitch of audio in the delay & reverb buffers. Subtle modulations of the sample rate give chorus-like effects. More drastic modulation causes more drastic effects – for example, jumping the sample rate up & down in octaves causes the reverb and delay tails to jump in octaves as well.

Changing the sample rate also affects EQ frequencies, and also changes the bandwidth of the audio. Lowering the sample rate by a fixed couple of octaves, for example, reduces the bandwidth to a nicely retro 12kHz – while also quadrupling the available delay and reverb times.

The 'Quantize' parameter, if active, limits the pitch changes to those in a musical scale. The options are the same as in the dual mode 'Quantizer' algorithm.

## **Outputs**

Outputs 1 & 2 present a mix according to parameters 10-15.

Outputs 3 & 4 present an auxiliary output according to parameter 63.

## **Aux input**

The 'Aux input L/R/gain' parameters allow you to mix an auxiliary signal into the output. This mix happens outside of the VSR processing and so is always done at the full 96kHz.

To mix a mono signal into the stereo output, select the same input for the L & R aux inputs.

## **MIDI support**

The 'Delay time' and 'Delay time R' parameters can optionally follow MIDI clock. This is enabled via the algorithm's menu:



When following MIDI clock, the parameter page shows 'MIDI', as well as the selected clock

division and the effective time in milliseconds:

```
12: Multi FX
43: Delay time
5
1/8 5 500ms MIDI
```

## Parameters

|     | Name             | Min  | Max | Default | Unit  | Description  |
|-----|------------------|------|-----|---------|-------|--|
| 1-6 | Attenuverter 1-6 | -200 | 200 | 100     | %     | Applies an attenuverter to the corresponding input. A negative value indicates that the CV will be inverted.   |
| 7   | VSR              | -80  | 80  | 0       | ST    | Sets the variable sample rate, in semitones. Note that the rate can only go downwards – positive values here will only have an effect if a negative CV is being applied. |
| 8   | VSR attenuator   | 0    | 100 | 100     | %     | An attenuator for the VSR CV input. You may need both this and the relevant attenuverter above to scale down a full-range LFO to a subtle pitch modulation.              |
| 9   | Quantize         | 0    | 16  | 0       |       | Sets the scale to quantize the VSR to, or '0' for 'Off'.   |
| 10  | Dry routing      | 0    | 1   | 0       |       | Sets the dry routing to Pre-EQ or Post-EQ.   |
| 11  | Dry gain         | -40  | 6   | 0       | dB    | The level of the dry signal mixed into the output.   |
| 12  | Effects gain     | -40  | 6   | 0       | dB    | The overall level of the combined effects signals mixed into the output.   |
| 13  | Pitch gain       | -40  | 6   | 0       | dB    | The level of the pitch effect mixed into the output.   |
| 14  | Delay gain       | -40  | 6   | 0       | dB    | The level of the delay effect mixed into the output.   |
| 15  | Reverb gain      | -40  | 6   | 0       | dB    | The level of the reverb mixed into the output.   |
| 16  | Saturation       | 0    | 1   | 1       |       | Enables saturation on the mix output.  |
| 17  | EQ 1 type        | 0    | 2   | 2       |       | The type of EQ band 1.   |
| 18  | EQ 1 frequency   | 0    | 127 | 26      |       | The frequency of EQ band 1.  |
| 19  | EQ 1 gain        | -120 | 120 | 0       | 0.1dB | The gain of EQ band 1 (only if type is 'Shelving').  |
| 20  | EQ 2 frequency   | 0    | 127 | 75      |       | The frequency of EQ band 2.  |
| 21  | EQ 2 Q           | 0    | 127 | 64      |       | The Q (resonance) of EQ band 2.  |
| 22  | EQ 2 gain        | -120 | 120 | 0       | 0.1dB | The gain of EQ band 2.   |
| 23  | EQ 3 type        | 0    | 2   | 2       |       | The type of EQ band 3.   |
| 24  | EQ 3 frequency   | 0    | 127 | 118     |       | The frequency of EQ band 3.  |

|    | <b>Name</b>                     | <b>Min</b> | <b>Max</b> | <b>Default</b> | <b>Unit</b> | <b>Description</b>   |
|----|---------------------------------|------------|------------|----------------|-------------|--|
| 25 | EQ 3 gain                       | -120       | 120        | 0              | 0.1dB       | The gain of EQ band 3 (only if type is 'Shelving').  |
| 26 | Pitch input 1                   | 0          | 4          | 1              |             | Chooses one input to the pitch effect.   |
| 27 | Pitch input 2                   | 0          | 4          | 3              |             | Chooses the other input to the pitch effect.   |
| 28 | Pitch input mix                 | -100       | 100        | -100           | %           | Sets the mix between pitch effect inputs (-100 is all input 1; 100 is all input 2).  |
| 29 | Pitch effect                    | 0          | 2          | 0              |             | Chooses the pitch effect (chorus, phaser, or pitch shift).   |
| 30 | Pitch blend                     | -100       | 100        | 100            | %           | Sets the mix at the pitch effect output between the input signal and the processed signal. Negative values crossfade between the input and processed signals; positive values add an amount of the processed signal to the input signal. |
| 31 | Pitch feedback                  | -100       | 100        | 0              | %           | The internal feedback of the pitch effect. Applies to all three effect modes, though the effect is different for each.   |
| 32 | Chorus delay/<br>Phaser centre  | 1          | 853        | 580            | 0.1ms       | The delay time of the chorus effect; OR the centre frequency of the phaser effect.   |
| 33 | Chorus speed/<br>Phaser speed   | 1          | 200        | 40             | 0.01<br>Hz  | The LFO speed of the chorus or phaser effect.  |
| 34 | Chorus depth/<br>Phaser depth   | 0          | 100        | 15             |             | The LFO depth of the chorus or phaser effect.  |
| 35 | Chorus spread/<br>Phaser spread | 0          | 360        | 180            |             | The stereo spread of the chorus or phaser effect, in degrees.  |
| 36 | Pitch shift<br>delay            | 1          | 200        | 200            | ms          | The delay time used by the pitch shifter effect.   |
| 37 | Pitch shift                     | -48        | 48         | 0              | ST          | The amount of pitch shifting, in semitones.  |
| 38 | Pitch shift<br>(fine)           | -100       | 100        | 0              | cents       | The amount of pitch shifting, in cents.  |
| 39 | Delay input 1                   | 0          | 4          | 1              |             | Chooses one input to the delay effect.   |
| 40 | Delay input 2                   | 0          | 4          | 2              |             | Chooses the other input to the delay effect.   |
| 41 | Delay input<br>mix              | -100       | 100        | -100           | %           | Sets the mix between delay effect inputs (-100 is all input 1; 100 is all input 2).  |
| 42 | Delay mode                      | 0          | 5          | 0              |             | Sets the delay mode.   |
| 43 | Delay time                      | 1          | 5000       | 500            | ms          | Sets the delay time, or the left delay time if the mode is 'stereo'.   |
|    | <i>or</i>                       | 1          | 18         | 5              |             | The delay time, if following MIDI clock.   |
| 44 | Delay time R                    | 1          | 5000       | 500            | ms          | Sets the right delay time if the mode is 'stereo'.   |
|    | <i>or</i>                       | 1          | 18         | 5              |             | The right delay time, if following MIDI clock.   |

|    | <b>Name</b>       | <b>Min</b> | <b>Max</b> | <b>Default</b> | <b>Unit</b> | <b>Description</b>  |
|----|-------------------|------------|------------|----------------|-------------|---|
| 45 | Delay feedback    | 0          | 100        | 50             | %           | Sets the delay feedback.  |
| 46 | Delay mono-ize    | 0          | 100        | 100            | %           | If the delay mode is 'ping-pong', sets the amount by which the input signal is reduced to a mono signal to be panned. |
| 47 | Delay initial pan | -100       | 100        | -100           |             | If the delay mode is 'ping-pong', sets the pan position of the first delay.   |
| 48 | Reverb input 1    | 0          | 4          | 1              |             | Chooses one input to the reverb.  |
| 49 | Reverb input 2    | 0          | 4          | 3              |             | Chooses the other input to the reverb.  |
| 50 | Reverb input mix  | -100       | 100        | -100           | %           | Sets the mix between reverb inputs (-100 is all input 1; 100 is all input 2).   |
| 51 | Reverb model      | 0          | 3          | 1              |             | Chooses the reverb model.   |
| 52 | Reverb time       | 400        | 30000      | 1000           | ms          | Sets the reverb time.   |
| 53 | Reverb size       | 1          | 100        | 100            | %           | Sets the size of the reverb space – mainly affects the times of the early reflections.                                |
| 54 | Reverb high damp  | 0          | 100        | 60             |             | Sets the amount of high frequency damping in the reverb tail.   |
| 55 | Reverb mod speed  | 1          | 500        | 250            | 0.01 Hz     | Sets the speed of reverb modulation.  |
| 56 | Reverb mod depth  | 0          | 100        | 25             |             | Sets the depth of reverb modulation.  |
| 57 | Reverb early gain | -40        | 6          | -12            | dB          | Sets the output level of the early reflections.   |
| 58 | Reverb diff gain  | -40        | 6          | -6             | dB          | Sets the output level of the diffuse reflections.   |
| 59 | Reverb low pass   | 0          | 127        | 100            |             | Sets the frequency of a first order low-pass filter applied at the reverb input.                                      |
| 60 | Mono input        | 0          | 1          | 0              |             | Sets whether the algorithm input is mono or stereo.   |
| 61 | VSR input         | 0          | 6          | 3              |             | Selects which input is used for the VSR CV, or '0' for 'None'.  |
| 62 | Pitch shift input | 0          | 6          | 4              |             | Selects which input is used for the pitch shift CV, or '0' for 'None'.  |
| 63 | Aux outputs       | 0          | 4          | 1              |             | Chooses which effect section's outputs appear on outputs 3 & 4.   |
| 64 | Aux input L       | 0          | 6          | 0              |             | Selects which input is mixed into the left channel as the aux signal, or '0' for 'None'.                              |
| 65 | Aux input R       | 0          | 6          | 0              |             | Selects which input is mixed into the right channel as the aux signal, or '0' for 'None'.                             |
| 66 | Aux input gain    | -40        | 6          | 0              | dB          | Sets the gain of the aux signal. '-40' is treated as $-\infty$ dB.  |



|    | <b>Name</b>         | <b>Min</b> | <b>Max</b> | <b>Default</b> | <b>Unit</b> | <b>Description</b>  |
|----|---------------------|------------|------------|----------------|-------------|---|
| 67 | Delay clock input   | 0          | 6          | 0              |             | Selects which input is used as a clock for the delay time, or '0' for 'None'.                       |
| 68 | Delay R clock input | 0          | 6          | 0              |             | Selects which input is used as a clock for the right delay time, or '0' for 'None'.                 |
| 69 | Delay multiplier    | 0          | 23         | 15             |             | A multiplier to apply to the delay time set by the clock. See above for the available values.       |
| 70 | Delay R multiplier  | 0          | 23         | 15             |             | A multiplier to apply to the right delay time set by the clock. See above for the available values. |

### ***Default mappings***

Input 3 is the 'VSR input'.

Input 4 is the 'Pitch shift input'.

Input 5 is mapped to 'Reverb time'.

## 13 – Poly Exciter

[Videos \(playlist\)](#) 



This algorithm is an 8 voice polyphonic synthesizer, based on the method of exciting a resonant structure with a burst of audio. It produces results that can sound like a stringed instrument being plucked/struck.

The 'exciter' can be one of those built into the algorithm itself, a WAV file loaded from the MicroSD card, or live audio patched into one of the module's inputs.

The algorithm can be played equally well by CV/gate or MIDI. When using CV/gate, the gate inputs are velocity-sensitive. In 'Strum' mode (see below) the algorithm works particularly well with aftertouch, and supports using the gate inputs as such.

Delay and chorus effects are built into the algorithm to enhance the overall sound.

Automatic chord generation and arpeggiation are provided.

The outputs can be a stereo or mono mix, or each voice can have its own output.

The algorithm supports microtonal tunings using Scala or MTS – see 'Scala support', above.

### **What is an 'exciter'?**

An exciter is simply a short (up to about half a second) burst of audio, which excites the resonator into oscillation. The exact timbre of the oscillation, especially early on, depends very much on the nature of the exciter; as the note rings out, it tends towards a simple, sine-like waveform.

You can use any audio as an exciter – it doesn't have to be specially created. Drum sounds are

interesting choices – try a bass drum for a softish sound, or a snare for a sound with a sharp, noisy attack. Audio files with sharp discontinuities tend to produce very pronounced 'pluck' sounds.

### **Built-in exciters**

Selecting “-1” for the Table parameter lets you choose a built-in waveform for the exciter. The options are as follows:

| Number | Name        | Description  |
|--------|-------------|--|
| 0      | Ramp        | A decaying linear ramp.  |
| 1      | Noise burst | White noise at a constant level.   |
| 2      | Noise ramp  | White noise, shaped by a decaying linear ramp.   |
| 3      | Square      | Constant maximum amplitude. Gives a strong pluck at the start <b>and</b> the end of the exciter (so, in Scrape mode, on key down <b>and</b> key up). |
| 4      | Silence     | Silence. Chiefly useful when an external audio signal is being processed.  |

### **Exciter files on the MicroSD card**

The algorithm contains some built-in exciters (chosen by setting the 'Table' parameter to -1) but more flexibility and creativity is possible when defining custom exciters. This is done by installing WAV files on the MicroSD card, in a manner very similar to how wavetables (see below) are installed.

There are some example exciters available to download [here](#)<sup>46</sup>.

All exciter tables go inside a folder at the top level of the MicroSD card named “exciters”. As with wavetables, exciter tables can either be a single WAV file, or a folder of individual WAV files, one per exciter. In either case, the sample rate of the WAV file is ignored, the samples are converted to 16 bit, and only the left channel of stereo files is loaded.

If the exciter table is a single file (directly within the “exciters” folder), it must contain exactly 128 exciters. The exciters can be any length, but they will be truncated at 28672 sample frames if longer.

If the exciter table is a folder, there can be any number of exciters, but only the first 128 (sorted alphabetically) will be used. Each exciter is a single WAV file, which can be any length, but only the first 28672 sample frames will be used.

In either case, exciters of less than 28672 sample frames are padded out with zeroes to the maximum length.

### **Processing external audio**

Use the 'Ext exciter input' parameter to choose a module input to use when processing external signals. (Note that all the inputs are mapped to parameters by default, so you'll need to unmap one of them to free up an input.)

The external audio is used **as well as** the built-in or MicroSD-sourced exciter. You may wish to choose the built-in exciter “Silence”.

The external signal does not need to be audio as such – interesting results can be achieved by feeding in, say, a square LFO, which will give rhythmic plucks at the LFO frequency.

---

<sup>46</sup> <https://expert-sleepers.co.uk/distingEXcontent.html>

## Algorithm-specific display

```
13 Poly Exciter
7:Mode
0 0 Strike
59 68 68 53 48 55 52 52
```

```
13 Poly Exciter
8:Table
8 8
multiplucks.wav
```

```
13 Poly Exciter
18:Veloc -> exciter
12 12
multiplucks.wav 009
```

For most parameters, the display shows the note numbers being played by the 8 voices, or "--" if a voice is not playing. On each voice is superimposed a vertical bar representing the voice's current envelope level. If the Table parameter is current, the bottom line shows the table name. For parameters which control modulation of the exciter number, the bottom line shows the current exciter for the last played note.

## Outputs

If 'Output mode' is 0, 1 or 2:

- Outputs 1 & 2 are the main stereo outputs.
- Output 4 is a mono mix of outputs 1 & 2.

If 'Output mode' is 3 ('Per voice'):

- Output 1 carries voices 1 & 5.
- Output 2 carries voices 2 & 6.
- Output 3 carries voices 3 & 7.
- Output 4 carries voices 4 & 8.

If you want to guarantee a single voice per output, you can set 'Max voices' to 4.

## MIDI support

This algorithm recognises note on, note off, pitch bend, polyphonic key pressure (aka aftertouch), and channel pressure (aka aftertouch) messages. It also recognises sustain (CC# 64) and All Notes Off (CC# 123 value 0), so these CCs are not available for MIDI mapping.

Notes received over MIDI (and I2C) use the 'Arpeggio 3 mode' and 'Arpeggio 3 range' parameters, and are treated as coming from gate 3 for the purposes enabling chord mode per gate.

Whether or not the algorithm responds to MIDI notes, and the range of notes to respond to, can be set from the algorithm's menu (in the same way as illustrated for the SD Multisample algorithm, above).

The 'Delay time' parameter can optionally follow MIDI clock. This is also enabled via the menu:

```
Options
Delay uses MIDI clk
```

```
Delay uses MIDI clk
i
```

When following MIDI clock, the parameter page shows 'MIDI', as well as the selected clock division and the effective time in milliseconds:

```
13 Poly Exciter
54:Delay time
5 1/8 5 500ms MIDI
```

## All notes off

If you encounter stuck notes or other issues, an 'All notes off' function is available from the algorithm's menu.

```
Poly Exciter
ns All notes off 0F
```

## Parameters

|     | Name             | Min  | Max | Default | Unit  | Description  |
|-----|------------------|------|-----|---------|-------|--|
| 1-6 | Attenuverter 1-6 | -200 | 200 | 100     | %     | Applies an attenuverter to the corresponding input. A negative value indicates that the CV will be inverted. |
| 7   | Mode             | 0    | 2   | 0       |       | See excitation modes, below.   |
| 8   | Table            | -1   | 999 | -1      |       | The chosen exciter table loaded from the MicroSD card, or -1 for the internal table.                         |
| 9   | Exciter          | 0    | 127 | 0       |       | The exciter number within the table.   |
| 10  | Exciter length   | 1    | 597 | 100     | ms    | The exciter length, in milliseconds.   |
| 11  | Tone             | 0    | 127 | 50      |       | Sets the tone (brightness) of the resonator.   |
| 12  | Damp             | 0    | 100 | 4       |       | Sets the amount of damping in the resonator.   |
| 13  | Release damp     | 0    | 100 | 0       |       | Sets the amount of extra damping added when a note is released.  |
| 14  | Pressure         | 0    | 127 | 0       |       | Sets the baseline pressure applied. See excitation modes, below.   |
| 15  | Veloc -> strike  | 0    | 100 | 100     | %     | The amount by which the note velocity affects the strength of the exciter.                                   |
| 16  | Veloc -> tone    | -100 | 100 | 0       | %     | The amount by which the note velocity affects the tone.  |
| 17  | Veloc -> damp    | -100 | 100 | 0       | %     | The amount by which the note velocity affects the damping.   |
| 18  | Veloc -> exciter | -127 | 127 | 0       |       | The amount by which the note velocity affects the chosen exciter within the table.                           |
| 19  | Pitch -> damp    | -100 | 100 | 0       | %     | The amount by which the note pitch affects the damping.  |
| 20  | Pitch -> exciter | -100 | 100 | 0       | %     | The amount by which the note pitch affects the chosen exciter within the table.                              |
| 21  | Pitch -> LPF     | -100 | 100 | 0       | %     | The amount by which the note pitch affects the low pass filter.  |
| 22  | Press -> exciter | -127 | 127 | 0       |       | The amount by which pressure affects the chosen exciter within the table.                                    |
| 23  | Env -> pitch     | -120 | 120 | 0       |       | The amount by which the envelope affects the note pitch (in units of 1/10 <sup>th</sup> semitones).          |
| 24  | Env -> exciter   | -127 | 127 | 0       |       | The amount by which the envelope affects the chosen exciter within the table.                                |
| 25  | LFO -> pitch     | -200 | 200 | 0       | cents | The amount by which the LFO affects the note pitch.  |
| 26  | LFO -> exciter   | -127 | 127 | 0       |       | The amount by which the LFO affects the chosen exciter within the table.                                     |

|       | Name               | Min  | Max | Default | Unit  | Description  |
|-------|--------------------|------|-----|---------|-------|--|
| 27    | LFO speed          | -100 | 100 | 90      |       | The LFO speed. Range 0.01Hz-10Hz.  |
| 28    | Attack time        | 0    | 127 | 60      |       | Envelope attack time. Range 1ms-15s.   |
| 29    | Decay time         | 0    | 127 | 70      |       | Envelope decay time. Range 20ms-15s.   |
| 30    | Sustain level      | -127 | 127 | 0       |       | Envelope sustain level.<br>Note that this can go negative.   |
| 31    | Release time       | 0    | 127 | 50      |       | Envelope release time. Range 10ms-30s.   |
| 32    | Coarse tune        | -60  | 60  | 0       |       | Transposes the whole instrument in semitones.  |
| 33    | Fine tune          | -100 | 100 | 0       | cents | Tunes the whole instrument in cents.   |
| 34    | Gain               | -40  | 24  | 0       | dB    | Applies an overall output gain.  |
| 35    | Sustain            | 0    | 1   | 0       |       | Activates sustain (notes remain playing when the gate goes low).   |
| 36    | Bend range         | 0    | 48  | 2       |       | The pitch bend range, in semitones. Applies both to MIDI pitch bend, and to CV pitch bend, in which case a CV of $\pm 5V$ maps to the chosen bend range.   |
| 37    | Chord enable       | 0    | 7   | 0       |       | Enables the chord generator function. (Note: the arpeggiator also requires this to be active.) The chord generator can be on or off globally, or per gate (MIDI/I2C counts as gate 3).   |
| 38    | Chord key          | -12  | 12  | 0       |       | The key of the chord generator. "0" is C, "1" is C#/D $\flat$ etc.   |
| 39    | Chord scale        | 0    | 7   | 0       |       | The scale of the chord generator. See below for the options.   |
| 40    | Chord shape        | 0    | 13  | 0       |       | The shape of the chord generator. See below for the options.   |
| 41    | Chord inversion    | 0    | 3   | 0       |       | The chord inversion. For example the first inversion takes the first note of the chord and moves it an octave up, so the lowest note in the chord is now the second (e.g. C E G becomes E G C). See e.g. <a href="https://en.wikipedia.org/wiki/Inversion_(music)#Inversions">here</a> <sup>47</sup> for a fuller explanation of inversions. |
| 42-44 | Arpeggio 1-3 mode  | 0    | 14  | 0       |       | The arpeggiator mode for each CV/gate input pair. See below for the options.   |
| 45-47 | Arpeggio 1-3 range | 1    | 3   | 1       |       | When set to 1, the arpeggio is simply the notes formed by the chord. When set to 2 or 3, a copy of the chord is appended to the pattern, one or two octaves higher, creating a longer pattern that spans multiple octaves.   |
| 48    | Scala/MTS          |      |     | 0       |       | Sets the Scala scale or MTS tuning to use. See above.  |

<sup>47</sup> [https://en.wikipedia.org/wiki/Inversion\\_\(music\)#Inversions](https://en.wikipedia.org/wiki/Inversion_(music)#Inversions)

|    | Name              | Min  | Max   | Default | Unit  | Description   |
|----|-------------------|------|-------|---------|-------|---|
| 49 | Scala KBM         |      |       | 0       |       | Sets the Scala keyboard map to use. See above.  |
| 50 | Low pass filter   | 0    | 127   | 126     |       | Sets the frequency of a first-order low pass filter applied to each note.   |
| 51 | Chorus mode       | 0    | 2     | 0       |       | Engages the chorus effect, or '0' for 'off'. <sup>48</sup>  |
| 52 | Delay mode        | 0    | 2     | 0       |       | The type of delay effect: 'Off', 'Stereo' or 'Ping-pong'.   |
| 53 | Delay level       | -40  | 0     | -3      | dB    | The level of the delay effect. '-40' is treated as $-\infty$ dB.  |
| 54 | Delay time        | 1    | 10000 | 500     | ms    | The delay time, in milliseconds.  |
|    | <i>or</i>         | 1    | 18    | 5       |       | The delay time, if following MIDI clock.  |
| 55 | Delay feedback    | 0    | 100   | 50      | %     | The delay feedback.   |
| 56 | Unison            | 1    | 8     | 1       |       | The number of voices to play simultaneously for each note triggered.  |
| 57 | Unison detune     | 0    | 100   | 10      | cents | The detune amount when Unison is active.  |
| 58 | Output spread     | -100 | 100   | 0       | %     | The amount of output spread, if the selected output mode uses spread.   |
| 59 | Break time        | 0    | 1000  | 0       | ms    | The 'break' time for chords, or “0” for off. See above.   |
| 60 | Break direction   | 0    | 2     | 0       |       | The 'break' direction. See above.   |
| 61 | Output mode       | 0    | 3     | 0       |       | The output mode – see above for details.  |
| 62 | Input mode        | 0    | 18    | 1       |       | Sets how many input CV/gate pairs the algorithm uses, and whether the gates are in fact pressure inputs. See below.   |
| 63 | Sustain mode      | 0    | 1     | 0       |       | Sets the behaviour of the sustain function. The options are “Synth” (sustained notes cannot be retriggered) and “Piano” (sustained notes can be retriggered). |
| 64 | MIDI vel curve    | 0    | 3     | 0       |       | Selects a velocity curve applied to incoming MIDI notes.  |
| 65 | Ext exciter input | 0    | 6     | 0       |       | The external exciter input, or “0” for none.  |
| 66 | Pitch bend input  | 0    | 6     | 0       |       | The pitch bend input, or “0” for none.  |
| 67 | Arp reset input   | 0    | 6     | 0       |       | The input to use as the arpeggiator reset, or “0” for none. A trigger pulse into this input will reset the arpeggiator back to step 1.                        |

<sup>48</sup> The chorus effect is unapologetically modelled on that of the classic Juno-6 polysynth, based on measurements of the author's own unit.

|    | <b>Name</b>   | <b>Min</b> | <b>Max</b> | <b>Default</b> | <b>Unit</b> | <b>Description</b>   |
|----|---------------|------------|------------|----------------|-------------|--|
| 68 | Max voices    | 1          | 8          | 8              |             | Sets the maximum number of simultaneous voices.  |
| 69 | LFO retrigger | 0          | 1          | 0              |             | Sets whether the LFOs are retriggered at note on. The options are 'Poly' (each voice's LFO triggers independently), or 'Off' (LFOs are free-running).  |
| 70 | LFO spread    | 0          | 90         | 0              |             | Sets the phase to which LFOs are retriggered. The value, in degrees <sup>49</sup> , is multiplied by the voice number to give the initial LFO phase. When retrigger is off, this sets the phase relationship between the free-running LFOs.          |
| 71 | Gate offset   | 0          | 496        | 0              |             | Offsets (delays) the gate inputs relative to the pitch inputs. This is useful to allow pitch CVs to settle before they are sampled on the rising gate, and also to cope with modules which output both a pitch and gate but change their gate first. |

### ***Default mappings***

Input 1 is mapped to 'Pressure'.

Input 3 is mapped to 'Sustain'.

Input 5 is mapped to 'Tone'.

Input 6 is mapped to 'Damp'.

### ***Excitation modes***

There are three modes available.

In 'Strike' mode, the exciter is played once, when a note is triggered. The whole duration, as set by the 'Exciter length' parameter, is played.

'Scrape' mode is similar, except that the exciter stops playing if the note is released before the exciter ends naturally.

In 'Strum' mode, the exciter plays continuously, in a loop, while the note is held.

The strength of the exciter is determined by the note velocity (according to the 'Veloc -> strike' parameter) and its pressure. In Strike and Scrape modes, notes default to full pressure; in Strum mode notes have a default pressure of zero. To this is added the 'Pressure' parameter, the MIDI channel and polyphonic pressures (if playing via MIDI), and the pressure from the input (if playing via CV/pressure pairs – see Input modes, below). So, **Strum mode will be silent** unless you give it pressure from one of these sources.

### ***Input modes***

The 'Input mode' parameter controls how many of the module's inputs are used as CV/gate inputs. The options are as follows. Remember that holding 'V' shows you what the inputs are being used

---

<sup>49</sup> 360° per LFO cycle.



for.

|                             |   |
|-----------------------------|---|
| <b>No CV/Gate inputs</b>    | Select this if you're playing the module by MIDI or I2C and want the maximum number of CV inputs for parameter mapping. |
| <b>1 CV/Gate pair</b>       | Uses input 2 for pitch and 4 for gate.  |
| <b>2 CV/Gate pairs</b>      | As above plus input 1 for pitch and 3 for gate.   |
| <b>3 CV/Gate pairs</b>      | As above plus input 5 for pitch and 6 for gate.   |
| <b>2 CVs/1 Gate</b>         | Uses inputs 1 & 2 for pitch and 4 for gate.   |
| <b>3 CVs/1 Gate</b>         | Uses inputs 1, 2 & 5 for pitch and 4 for gate.  |
| <b>4 CVs/1 Gate</b>         | Uses inputs 1, 2, 5 & 6 for pitch and 4 for gate.   |
| <b>5 CVs/1 Gate</b>         | Uses inputs 1, 2, 3, 5 & 6 for pitch and 4 for gate.  |
| <b>2x 2 CVs/1 Gate</b>      | Two sets: 1 & 2 (pitch)/4 (gate), 5 & 6 (pitch)/3 (gate).   |
| <b>3 CVs/Gate + CV/Gate</b> | Two sets: 1, 2 & 5 (pitch)/4 (gate), 6 (pitch)/3 (gate).  |

After these options, the same pattern repeats again, but with 'Pressure' instead of 'Gate'.

When 'Input mode' is 0, the module's CV inputs are not used for note triggering (presumably you'll use MIDI or I2C instead) and are all available for other uses (e.g. parameter mapping).

When using the 'CV/Gate' modes, the gate inputs are standard on/off triggers. The global 'Gate CV threshold' setting applies.

When using the 'CV/Pressure' modes, the gate inputs are in fact 'pressure' inputs. A note is triggered when its pressure input rises above 200mV, and then that input is used directly as the note's pressure (corresponding to polyphonic aftertouch in the MIDI world), scaled such that 5V corresponds to full pressure.

## **Output modes**

The available values for the 'Output mode' parameter are as follows:

| <b>Value</b> | <b>Name</b>       | <b>Description</b>  |
|--------------|-------------------|---|
| 0            | Spread by voice   | Voices are spread across the stereo field from left to right.   |
| 1            | Spread by voice 2 | Voices are spread across the stereo field in an alternating left/right manner, by a small amount for voices 1/2, increasing up to voices 7/8. |
| 2            | Spread by pitch   | Voices are spread across the stereo field according to their pitch, with note 48 at the centre.   |
| 3            | Per voice         | Each voice comes out of one output only, as described above.  |

## **Tap tempo**

When the 'Delay time' parameter is current, pressing the 'R' button acts as a 'tap tempo' function to set the delay time (instead of resetting the parameter to its default value).

## **Chords and arpeggiators**

The various chord and arpeggiator parameters are exactly the same as those in the SD Multisample

algorithm. Please refer to the documentation of that algorithm, above.

### ***Scala and MTS support***

This algorithm's Scala and MTS (MIDI Tuning Standard) parameters are also the same as those for the SD Multisample algorithm – see above. Unlike the SD Multisample algorithm however, this algorithm updates its tuning on the fly as you switch between scales/keyboard mappings.

## 14 – Quad Envelope

[Video](#) 

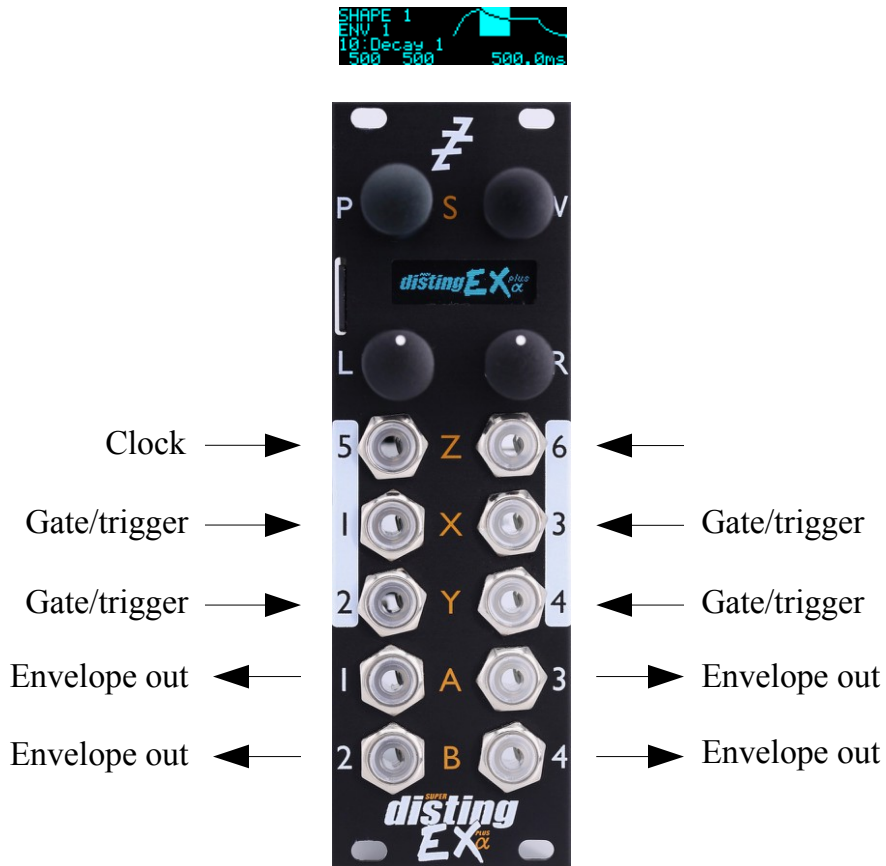

This algorithm is a quad complex (DAHDSR) envelope generator, with optional VCA functionality. Various trigger modes include gated, triggered (one-shot) and looping. The envelopes can be synced to clocks (analogue pulses, or MIDI).

### 'Shapes' and 'Envelopes'

This algorithm separates the concepts of an envelope shape (its attack etc. times, sustain level) and the envelope generator itself. There are four of each. By default, each envelope generator has its own shape.

You can however share shapes between the generators. For example, in the case of a four voice polyphonic synth, you might want four envelopes, all using the same shape. By sharing the shape between the generators, you only need to edit e.g. one attack time to change the attack time for all four voices.

At the other extreme, you might want to have four different shapes, but share a common trigger – for example, to modulate four different parts of a monophonic patch.

### VCA's

If a VCA input is chosen by the envelope's 'Inputs' parameter, the signal on that input is multiplied by the envelope, and that signal appears at the envelope's output. This is scaled so that an envelope

with a nominal 8V range achieves unity gain for the VCA.

Note that the VCA path is DC coupled, and that if the envelope's offset has been used to make it negative or bipolar, the multiplication is four-quadrant, meaning you can use this for fairly complex CV modulation, as well as for the common-or-garden usage of modulating an audio source's volume.

## Algorithm-specific display



When a shape parameter is current, the display shows a graphical representation of the envelope shape. The section that is currently being edited is highlighted. To the left, the list of envelopes (if any) that are using this shape is shown.



When an envelope parameter is current, the display shows a graphical representation of the envelope shape. The section that is currently being output (if any) is highlighted. Furthermore, when one of the clock parameters is current, the duration of the last clock is also shown.

The algorithm has a special display mode which shows an overview of all four envelopes. This is accessed by double-clicking the 'V' knob.



The currently active region of each envelope is highlighted.

You can optionally set this mode to appear automatically when the interface is otherwise idle. Do this via the 'Auto visuals' option under the algorithm's menu. The value is a time in seconds, or zero to disable this feature.



If you double-click 'V' to exit the visuals display mode, 'Auto visuals' will not apply until you double-click again to enter the mode.

Another option, 'MIDI leaves visuals', causes the display to automatically revert to the normal display mode when a parameter change is received via MIDI.



The options are 'Off', 'All' and 'Most'. 'Most' remains in the visuals mode if the MIDI parameter change affects one of the shape parameters.

## Outputs

Outputs 1-4 correspond to envelopes 1-4 respectively. If the envelope has a VCA input specified, the output is conceptually the VCA output, not the envelope itself. If you want the envelope output and the VCA output, simply duplicate the settings across two envelope generators.

## ES-5 outputs

If an ES-5 is connected (see above), ES-5 outputs 1-4 emit “end of cycle” trigger pulses whenever the corresponding envelope goes idle (at the end of its release phase), and ES-5 outputs 5-8 output

“active” gate signals i.e. the outputs are on while the envelope is active.

## **MIDI support**

This algorithm recognises note on & note off messages. Notes 48-51 trigger envelopes 1-4 respectively.

It also recognises MIDI clock, which can be used as a clock source via the 'Clock input' parameters.

Whether or not the algorithm responds to MIDI notes, and the range of notes to respond to, can be set from the algorithm's menu (in the same way as illustrated for the SD Multisample algorithm, above).

## **Parameters**

|       | <b>Name</b>      | <b>Min</b> | <b>Max</b> | <b>Default</b> | <b>Unit</b> | <b>Description</b>   |
|-------|------------------|------------|------------|----------------|-------------|--|
| 1-6   | Attenuverter 1-6 | -200       | 200        | 100            | %           | Applies an attenuverter to the corresponding input. A negative value indicates that the CV will be inverted. |
| 7     | Delay 1          | 0          | 1000       | 0              |             | The delay time for shape 1. In milliseconds, multiplied by the Range parameter.                              |
| 8     | Attack 1         | 0          | 1000       | 500            |             | The attack time for shape 1.   |
| 9     | Hold 1           | 0          | 1000       | 0              |             | The hold time for shape 1.   |
| 10    | Decay 1          | 0          | 1000       | 500            |             | The decay time for shape 1.  |
| 11    | Sustain 1        | -1000      | 1000       | 600            |             | The sustain level for shape 1.   |
| 12    | Release 1        | 0          | 1000       | 500            |             | The release time for shape 1.  |
| 13    | Attack shape 1   | 0          | 127        | 64             |             | The attack curve shape for shape 1. Low values are more exponential; high values more linear.                |
| 14    | Decay shape 1    | 0          | 127        | 64             |             | The decay and release curve shapes for shape 1. Low values are more exponential; high values more linear.    |
| 15    | Range 1          | 0          | 4          | 2              |             | The time range (multiplier) for shape 1.   |
| 16-24 |                  |            |            |                |             | As above, for shape 2.   |
| 25-33 |                  |            |            |                |             | As above, for shape 3.   |
| 34-42 |                  |            |            |                |             | As above, for shape 4.   |
| 43    | Inputs 1         | 0          | 48         | 1              |             | The inputs to use for envelope 1 – see below.  |
| 44    | Shape 1          | 1          | 4          | 1              |             | Which shape to use for envelope 1.   |
| 45    | Trigger mode 1   | 0          | 5          | 0              |             | The trigger mode for envelope 1 – see below.   |
| 46    | Clock input 1    | 0          | 24         | 5              |             | The clock input for envelope 1 – see below.  |

|       | <b>Name</b>     | <b>Min</b> | <b>Max</b> | <b>Default</b> | <b>Unit</b> | <b>Description</b>  |
|-------|-----------------|------------|------------|----------------|-------------|---|
| 47    | Clock mode 1    | 0          | 3          | 0              |             | The clock mode for envelope 1 – see below.  |
| 48    | Scale 1         | -100       | 100        | 80             |             | The scale for envelope 1, in units of 100mV i.e. the full scale is $\pm 10V$ . Negative values invert the envelope. |
| 49    | Offset 1        | -100       | 100        | 0              |             | The DC offset for envelope 1, in units of 100mV i.e. the full scale is $\pm 10V$ .                                  |
| 50    | Vel -> scale 1  | 0          | 100        | 100            | %           | The amount by which the trigger velocity affects the envelope scale.  |
| 51    | Vel -> attack 1 | -100       | 100        | 0              | %           | The amount by which the trigger velocity affects the envelope attack time.  |
| 52-60 |                 |            |            |                |             | As above, for envelope 2. The 'Inputs' and 'Shape' default to 2.  |
| 61-69 |                 |            |            |                |             | As above, for envelope 3. The 'Inputs' and 'Shape' default to 3.  |
| 70-78 |                 |            |            |                |             | As above, for envelope 4. The 'Inputs' and 'Shape' default to 4.  |
| 79    | MIDI vel curve  | 0          | 3          | 0              |             | Selects a velocity curve applied to incoming MIDI notes.  |

### ***Default mappings***

There are no default mappings.

### ***Press to trigger***

Unless it is mapped to another function, pressing 'L' while an envelope parameter is current triggers that envelope; pressing 'L' while a shape parameter is current triggers all envelopes using that shape.

### ***Input selection***

The 'Inputs' parameter for each envelope lets you choose the trigger/gate input, and the VCA input. Note that if no trigger input is specified (e.g. “Trig -” or “Trg - VCA 2”) the envelope can still be triggered by MIDI or by its clock input.

### ***Trigger modes***

The available trigger modes are as follows:

| <b>Mode</b> | <b>Behaviour</b>  |
|-------------|---|
| Gate        | The envelope is triggered by a rising edge (or MIDI note on). If it reaches the sustain stage, it stays there while the gate is high (or the MIDI note is held). When the gate goes low (or the MIDI note is released) the envelope moves immediately to the release stage, whichever stage it is in at the time. |

| <b>Mode</b>          | <b>Behaviour</b>   |
|----------------------|--|
| Trigger              | The envelope is triggered by a rising edge (or MIDI note on). It moves through its delay, attack, hold, decay and release stages once, and then is idle. |
| Gated loop           | The envelope loops round its delay, attack, hold, decay and release stages as long as the gate is high (or the MIDI note held).                          |
| Looping              | The envelope loops forever, once triggered.  |
| Trigger by clock     | As 'Trigger', but triggered by whatever is specified for the envelope's clock input. It may still be triggered by its trigger input, or MIDI.            |
| Trigger no retrigger | As 'Trigger', but the envelope cannot be retriggered while it's active. It always completes a full cycle before it can start again.                      |

## ***Clock inputs***

The 'Clock inputs' parameter works in conjunction with 'Clock mode'. You must specify a clock input, or no clock mode will work.

The options are 'None', one of the module's six inputs, or a MIDI clock divisor.

MIDI clock divisors are specified as e.g. "MIDI 1/4" which means quarter notes; "MIDI 1/8T" means eighth note triplets etc.

## ***Clock modes***

If a clock input is specified, the following clock modes are available. The 'clock time' is defined as the time between successive clock pulses.

| <b>Mode</b>     | <b>Description</b>   |
|-----------------|--|
| Off             | No clocked behaviour.  |
| No stretch      | If the clock time is less than the total envelope time (the sum of the delay, attack, hold, decay and release times), the envelope's overall time is shrunk to match the clock time. If the clock time is longer than the total envelope time, the envelope's time is unchanged. |
| Stretch all     | The overall envelope time is matched to the clock time, by stretching or reducing each stage time proportionally.  |
| Stretch sustain | If the clock time is less than the total envelope time, the envelope's overall time is shrunk to match the clock time. If the clock time is longer than the total envelope time, a sustain stage is introduced to make the overall time match the clock time.                    |

## 15 – Convolver

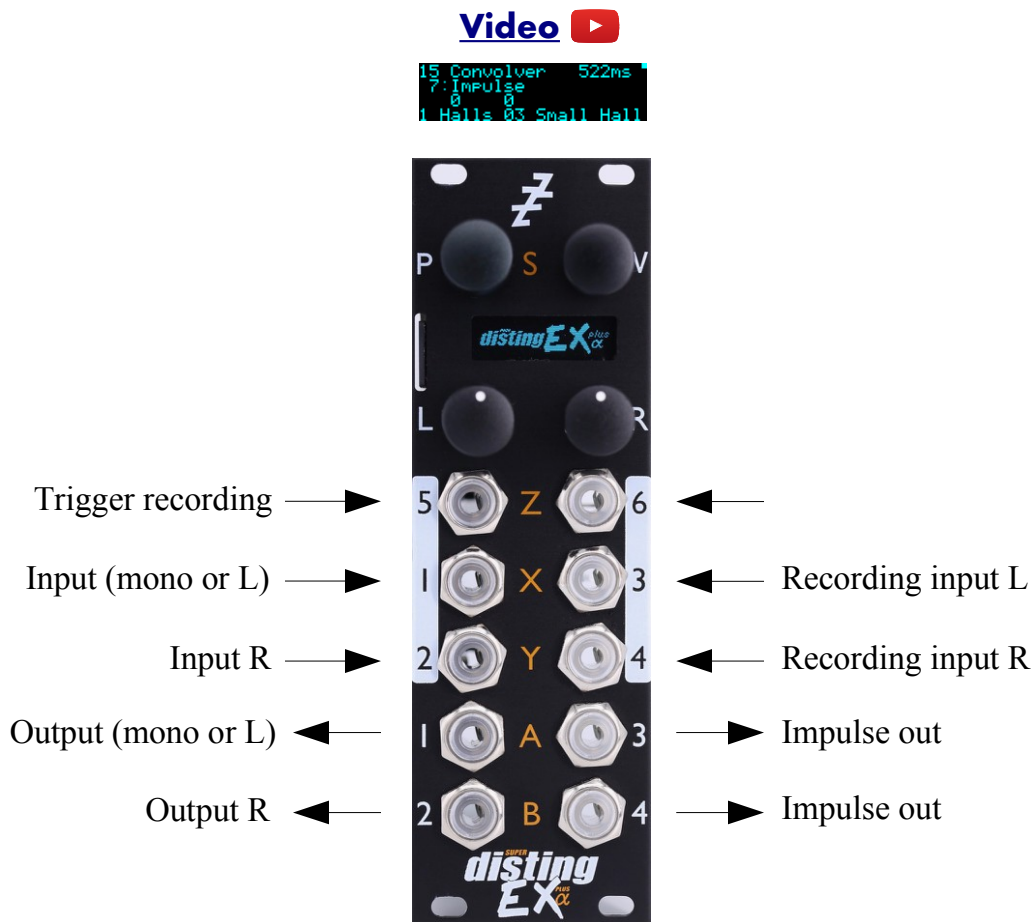

This algorithm performs real-time [convolution](#)<sup>50</sup> of the input signal and another signal (often called an 'impulse response') which can be loaded from the MicroSD card or recorded live into the module's memory.

This is often used for realistic reverb effects, since the required impulse responses can be sampled from a physical location, but the technique is much more general and can be a very creative way to mangle and combine sounds.

Convolution is notoriously CPU-intensive, and the disting EX is a resource-constrained embedded system – you should not expect to achieve the same results as you might in the latest new fangled convolution reverb plug-in in your DAW, with orders of magnitude more CPU power and RAM. However, this algorithm remains a useful tool within the context of a modular synth.

### ***Impulse length and the factors that affect it***

When choosing the parameters for this algorithm there are various trade-offs to be made, all of which affect the maximum length of impulse response that you can use. (A longer impulse response is usually desirable, especially if you're using this for reverb.) These factors are:

**Mono vs stereo:** if the output is stereo, the algorithm has to do almost twice the work, so the impulse time is more or less halved. Using the 'Channels' parameter, you can select mono, mono-to-stereo, or stereo operation. The last two count as stereo in terms of processing time. Note that the

<sup>50</sup> <https://en.wikipedia.org/wiki/Convolution>



stereo option passes the dry signal in stereo but sums the two input channels to mono before convolution; it does not do true stereo convolution, which would double the CPU cost again.

**Latency:** the algorithm works on blocks of audio at a time. It is more efficient to work on larger blocks, but conversely using larger blocks means a longer wait until you get the results i.e. higher latency. The Latency parameter offers you the choice between lower latency with smaller impulse time, or higher latency with longer impulse time. Note that in either case, the dry signal is still synced up with the convolution result. So for example you could use this as a master bus insert effect to put a nice reverb on your whole mix and probably get away with a long latency.

**Sample rate:** the disting EX's algorithms all run at 96kHz. However, by downsampling to a lower sample rate internally, a given time's worth of audio is cheaper to process and a longer impulse time can be achieved, at the expense of the bandwidth of the processed audio. The 'Sample rate' parameter offers several choices, from a high-quality 48kHz to a decidedly murky 6kHz. Note that the dry signal is always pristine 96kHz.

Combining all of these factors, the possible range of impulse times is quite large – from 66ms (stereo, 5ms latency, 48kHz) to over 5 seconds (mono, 43ms latency, 6kHz). The maximum impulse time is shown in the upper right of the display.

### ***Impulse responses on the MicroSD card***

Impulse response files should be placed in a folder called 'impulses' on the MicroSD card. Any kind of WAV file is supported, but stereo 32 bit float is preferred. For fastest loading, choose a sample rate for the file equal to the sample rate at which you want to run the algorithm, but other sample rates will be converted.

There are plenty of free examples online, for example [these](#)<sup>51</sup> by EchoThief, or [these](#)<sup>52</sup> rather lovely Bricasti M7 impulses. You may find that you have a plug-in in your DAW which contains a library of impulse responses (e.g. Live's Hybrid Reverb) that you could copy to the MicroSD card.

### ***Recording impulse responses into the algorithm***

Using pre-recorded impulse responses is all well and good, but a lot of the fun here comes from recording your own.

Connect the audio to be recorded to the disting's inputs 3 & 4. (It always records in stereo, even if the algorithm is running mono.)

There are two ways to begin recording. The first is to supply a trigger to input 5. There are two options, according to the 'Trigger mode' parameter. 'Triggered' records for as long as it can; 'Gated' records only while the trigger input is high.

The second way to begin recording is to use the 'Generate impulse' parameter. When this changes from 0 to 1, a click is generated on outputs 3 & 4, and then recording begins. By default this parameter is mapped to the L button, so you can simply press the button to begin recording. You may also choose to map this parameter to MIDI, I2C, or a spare CV input.

If you feed the click from outputs 3 & 4 through another module, for example a reverb, you should get something that sounds like a typical impulse response.

It should be emphasised that you can record **absolutely any audio** as an impulse response. The end result will vary wildly depending on the audio in question, but in general consider that convolution

---

51 <http://www.echothief.com/downloads/>

52 <https://web.archive.org/web/20190201211631/http://www.samplicity.com/bricasti-m7-impulse-responses/>

is in some sense filtering one sound with another. A noisy signal tends to bring out all frequency components of the other signal – so for example a noisy impulse (like a typical reverb impulse) will be fairly frequency-neutral on the live audio, and a noisy signal (e.g. a drum loop) will bring out most of the frequency content of a pitched impulse (e.g. a short recording of a voice). If both impulse and live signal are pitched, you can get some very strong resonant effects.

## Saving your recorded impulses

You can save your recordings to the MicroSD card from the algorithm's menu.



The saved file is placed in the 'impulses' folder.

The files are usable by the algorithm, but aren't immediately visible in the list for the Impulse parameter. To make them so, exit and re-enter the algorithm, or use the 'Rescan impulses' menu:

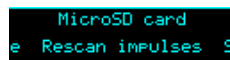

## Live update

Normally, when you record an impulse, the convolution output is muted while the new impulse is recorded and processed. The 'Live update' parameter gives you the option to maintain convolution output during recording and processing, and the expense of halving the maximum impulse time.

In either case, the dry signal continues uninterrupted during recording and processing.

## Outputs

Outputs 1 & 2 are a mix of the dry and convolution signals according to the 'Dry gain' and 'Convolution gain' parameters.

Outputs 3 & 4 are the impulse signal generated when 'Generate impulse' is used.

## Parameters

|     | Name             | Min  | Max | Default | Unit | Description  |
|-----|------------------|------|-----|---------|------|--|
| 1-6 | Attenuverter 1-6 | -200 | 200 | 100     | %    | Applies an attenuverter to the corresponding input. A negative value indicates that the CV will be inverted. |
| 7   | Impulse          | 0    | 999 | 0       |      | Chooses the impulse response file to load from the MicroSD card.   |
| 8   | Dry gain         | -40  | 12  | 0       | dB   | The dry signal level in the output mix. '-40' is treated as $-\infty$ dB.                                    |
| 9   | Convolution gain | -40  | 12  | 0       | dB   | The convolution signal level in the output mix. '-40' is treated as $-\infty$ dB.                            |
| 10  | Trigger mode     | 0    | 1   | 0       |      | The recording trigger mode.  |
| 11  | Channels         | 0    | 2   | 0       |      | Sets the mono or stereo usage of the inputs and outputs.   |
| 12  | Latency          | 0    | 3   | 2       |      | Sets the algorithm's latency.  |

|    | <b>Name</b>      | <b>Min</b> | <b>Max</b> | <b>Default</b> | <b>Unit</b> | <b>Description</b>  |
|----|------------------|------------|------------|----------------|-------------|---|
| 13 | Sample rate      | 0          | 3          | 0              |             | Sets the algorithm's sample rate.                         |
| 14 | Live update      | 0          | 1          | 0              |             | Enables the 'live update' mode.                           |
| 15 | Generate impulse | 0          | 1          | 0              |             | Generates an impulse and enables recording when set to 1. |

### ***Default mappings***

The 'L' button is mapped to 'Generate impulse'.

## 16 – Chord Engine

[Videos \(Playlist\)](#) 

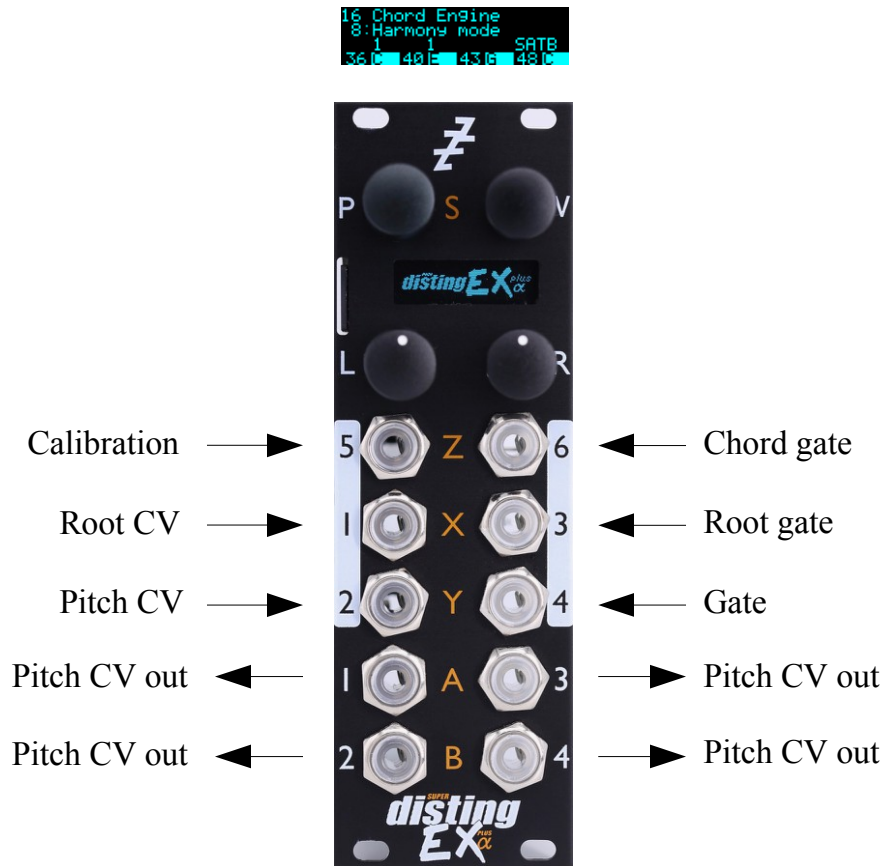

This algorithm generates chords of pitch CVs from an input pitch CV, with a number of options for how the harmony CVs are worked out.

The algorithm can also operate as a polyphonic voice distributor, in which case it can optionally arpeggiate the voices using the generated chord. (It will also work as a monophonic arpeggiator.)

The pitch outputs can be tuned microtonally using Scala or MTS.

There is also a built-in automatic calibration process to save having to manually tune all four possible VCOs that are under the algorithm's control.

### **Chord mode**

If the 'Operation mode' parameter is set to 'Chord', the algorithm follows a pitch CV and generates four harmonically related pitch CVs, according to the chosen key and scale.

### **Harmony modes**

There are two different ways in which the chord notes can be chosen.

The first, 'Shape mode', builds up a chord using the input CV as the root note, according to the shape and inversion parameters. This is the same method that has been used for some time by other disting EX algorithms (e.g. SD Multisample).

The second, 'SATB mode', builds a chord according to common practice<sup>53</sup> four part harmony. (SATB stands for soprano/alto/tenor/bass.) The input CV is assigned to one of the four voices according to the 'cantus firmus' parameter, and the remaining voices fill out the chord according to the root degree and position parameters. The root can also optionally be set from a CV input or via MIDI.

Note that the root is not the same as the key. In the key of C major for example, a root degree of II gives the chord D-F-A. In the key of D major, a root degree of I gives D-F#-A.

## ***Distribution mode***

If the 'Operation mode' parameter is set to one of the 'Distrib' options, the algorithm takes incoming notes and distributes them in round-robin fashion amongst a number of voices, allowing you to, for example, take a monophonic sequencer and use it to drive a polyphonic patch.

In these modes, you can also enable the arpeggiator. Much as in other algorithms which offer an arpeggiator feature, this then uses the generated chord and plays the chord's notes one at a time. This is the reason for the otherwise rather pointless 'Distrib 1' mode, which doesn't do any voice distribution as such but offers monophonic-to-monophonic arpeggiation.

## ***Algorithm-specific display***

The algorithm has a special display mode which shows the four notes of the generated chord, as MIDI note numbers and names. This is accessed by double-clicking the 'V' knob.

```
36 C | 43 G
-----
40 E | 48 C
```

You can optionally set this mode to appear automatically when the interface is otherwise idle. Do this via the 'Auto visuals' option under the algorithm's menu. The value is a time in seconds, or zero to disable this feature.



If you double-click 'V' to exit the visuals display mode, 'Auto visuals' will not apply until you double-click again to enter the mode.

## ***Outputs***

In Chord mode, or in Distrib 3 or 4 modes, outputs 1-4 are the pitch CVs for the four notes of the chord, or for the four voices when in distribution mode.

In Distrib 1 or 2 mode, outputs 1-2 are pitch CVs and outputs 3-4 are the corresponding gates.

## ***ES-5 outputs***

This algorithm will make use of an attached ES-5 expansion module, and indeed this is the only way to access the voice trigger/gate outputs when using more than two voices.

ES-5 output 1 outputs a trigger when the incoming CV is determined to have changed.

ES-5 output 2 outputs a trigger when the root note CV is determined to have changed.

In Chord mode, ES-5 output 3 outputs a trigger when any note in the chord changes.

ES-5 outputs 5-8 output per-voice triggers or gates, according to the 'Output gate mode' parameter.

53 [https://en.wikipedia.org/wiki/Common\\_practice\\_period](https://en.wikipedia.org/wiki/Common_practice_period)

This has the options 'Triggers', 'Inv Triggers' (inverted triggers, always high except for a low pulse when the trigger is fired, useful for driving an envelope generator which is generally in sustain but which needs to be retriggered when the chord changes), and 'Gates' (in which case the output is gated by the main gate input, input 4).

In Chord mode, outputs 5-8 fire when the corresponding note in the chord changes. In Distrib modes, outputs 5-8 fire when the corresponding voice plays.

## **MIDI support**

This algorithm recognises note on messages, which are used to set the 'Root degree' parameter. Notes C-B (in any octave) set the root degree to I-VII. Note that this always operates with C corresponding to I etc., whatever key the algorithm is actually working in.

The lowest octave (MIDI notes 0-11) additionally sets the 'Position' parameter to 'Close'; the second octave (MIDI notes 12-23) sets 'Position' to 'Open'.

Whether or not the algorithm responds to MIDI notes, and the range of notes to respond to, can be set from the algorithm's menu (in the same way as illustrated for the SD Multisample algorithm, above).

The algorithm can also output MIDI. See below.

## **Parameters**

|     | <b>Name</b>      | <b>Min</b> | <b>Max</b> | <b>Default</b> | <b>Unit</b> | <b>Description</b>   |
|-----|------------------|------------|------------|----------------|-------------|--|
| 1-6 | Attenuverter 1-6 | -200       | 200        | 100            | %           | Applies an attenuverter to the corresponding input. A negative value indicates that the CV will be inverted.   |
| 7   | Operation mode   | 0          | 4          | 0              |             | Chooses the function of the algorithm. The options are 'Chord', 'Distrib 1', 'Distrib 2' (note distribution over two voices), 'Distrib 3' (three voices), or 'Distrib 4' (four voices).  |
| 8   | Harmony mode     | 0          | 1          | 0              |             | Chooses the harmony mode: 'Shape' or 'SATB'.   |
| 9   | Chord key        | -12        | 12         | 0              |             | The key of the chord generator. "0" is C, "1" is C#/D $\flat$ etc.   |
| 10  | Chord scale      | 0          | 9          | 0              |             | The scale of the chord generator. See below.   |
| 11  | Chord shape      | 0          | 14         | 0              |             | Shape mode: the shape of the chord generator. See below.   |
| 12  | Chord inversion  | 0          | 3          | 0              |             | Shape mode: the chord inversion. For example the first inversion takes the first note of the chord and moves it an octave up, so the lowest note in the chord is now the second (e.g. C E G becomes E G C). See e.g. <a href="https://en.wikipedia.org/wiki/Inversion_(music)#Inversions">here</a> <sup>54</sup> for a fuller explanation of inversions. |
| 13  | Custom chord 1   | 0          | 63         | 0              |             | Shape mode: the first note of the custom chord. See below.   |

54 [https://en.wikipedia.org/wiki/Inversion\\_\(music\)#Inversions](https://en.wikipedia.org/wiki/Inversion_(music)#Inversions)

|       | <b>Name</b>      | <b>Min</b> | <b>Max</b> | <b>Default</b> | <b>Unit</b> | <b>Description</b>   |
|-------|------------------|------------|------------|----------------|-------------|--|
| 14-17 | Custom chord 2-5 | -1         | 63         |                |             | Shape mode: the second to fifth notes of the custom chord. See below.  |
| 18    | Root degree      | 0          | 7          | 1              |             | SATB mode: the root degree. Values of 1-7 correspond to degrees I-VII; or '0' to use the root CV input.  |
| 19    | Cantus firmus    | 0          | 3          | 3              |             | SATB mode: which voice corresponds to the input CV.  |
| 20    | Position         | 0          | 1          | 0              |             | SATB mode: Close (0) or Open (1) position.   |
| 21    | Lowest bass      | 0          | 127        | 28             |             | SATB mode: the lowest note of the preferred range for the bass voice.  |
| 22    | Highest bass     | 0          | 127        | 52             |             | SATB mode: the highest note of the preferred range for the bass voice.   |
| 23    | Arpeggio mode    | 0          | 14         | 0              |             | The arpeggiator mode. See below.   |
| 24    | Arpeggio range   | 1          | 3          | 1              |             | When set to 1, the arpeggio is simply the notes formed by the chord. When set to 2 or 3, a copy of the chord is appended to the pattern, one or two octaves higher, creating a longer pattern that spans multiple octaves. |
| 25    | Scala/MTS        |            |            | 0              |             | Sets the Scala scale or MTS tuning to use.   |
| 26    | Scala KBM        |            |            | 0              |             | Sets the Scala keyboard map to use.  |
| 27    | Input transpose  | -48        | 48         | 0              | ST          | Applies a transposition to the input CV.   |
| 28    | Input tune       | -100       | 100        | 0              | cents       | Applies a fine tune amount to the input CV.  |
| 29    | Output transpose | -48        | 48         | 0              | ST          | Applies a transposition to the output CVs.   |
| 30    | Output tune      | -100       | 100        | 0              | cents       | Applies a fine tune amount to the output CVs.  |
| 31    | Ouptut slew 1    | 0          | 127        | 0              |             | Sets the amount of slew to apply to the CV on output 1. '0' is none; values from 1 to 127 give slew times from 10ms to 5s.   |
| 32-34 | Ouptut slew 2-4  | -1         | 127        | -1             |             | Set the amount of slew to apply to the CVs on outputs 2-4. The special value '-1' means "use the same value as output 1".  |
| 35    | Note tracking    | 0          | 1          | 0              |             | Sets how the input CV is sampled. The options are 'Continuous' (0) or 'Triggered' (1). If Triggered, the CV is only sampled when the gate input goes high.   |

|    | <b>Name</b>      | <b>Min</b> | <b>Max</b> | <b>Default</b> | <b>Unit</b> | <b>Description</b>  |
|----|------------------|------------|------------|----------------|-------------|---|
| 36 | Root tracking    | 0          | 3          | 0              |             | Sets when the root note is sampled. The options are 'Continuous' (0), 'Triggered' (1) (when input 3 goes high), 'Trig with note' (2) (sample the root whenever the note is sampled), or 'When note changes' (3) (sample the root whenever the note changes).  |
| 37 | Chord tracking   | 0          | 3          | 0              |             | Sets when the chord is allowed to change. The options are 'Continuous' (0) (whenever any chord parameter changes), 'Triggered' (1) (when input 6 goes high), 'Trig with note' (2) (the chord may change when the note is sampled), or 'When note changes' (3) (the chord may change when the note changes).   |
| 38 | Output gate mode | 0          | 2          | 0              |             | Sets the behaviour of the gate/trigger outputs. See above.  |
| 39 | Input is 12-TET  | 0          | 1          | 1              |             | Sets whether the input CV is assumed to be in 12-TET, or in the tuning set by the Scala/MTS parameters.   |
| 40 | Gate offset      | 0          | 496        | 10             |             | Offsets (delays) the gate inputs relative to the pitch inputs. This is useful to allow pitch CVs to settle before they are sampled on the rising gate, and also to cope with modules which output both a pitch and gate but change their gate first.<br>In continuous tracking modes, this parameter sets a delay before a changing CV is actually sampled, to avoid generating a rapid series of notes in response to a non-instantaneous CV transition. |
| 41 | Arp reset input  | 0          | 6          | 0              |             | The input to use as the arpeggiator reset, or “0” for none. A trigger pulse into this input will reset the arpeggiator back to step 1.  |
| 42 | MIDI output      | 0          | 2          | 0              |             | Whether the algorithm outputs MIDI. See below.  |
| 43 | Break time       | 0          | 1000       | 0              | ms          | The 'break' time for chords, or “0” for off. See above.   |
| 44 | Break direction  | 0          | 2          | 0              |             | The 'break' direction. See above.   |

### ***Default mappings***

None.

### ***Chords and arpeggiators***

The various chord and arpeggiator parameters are largely the same as those in the SD Multisample



algorithm. Please refer to the documentation of that algorithm, above.

This algorithm adds an extra scale option, 'Melodic Minor'. When using this scale in SATB harmony mode, the cantus firmus uses the melodic minor scale<sup>55</sup>, using the ascending or descending form automatically depending on the voice movement. The remaining voices use the harmonic minor when generating the harmony.

This algorithm also adds an extra shape option, 'Custom'. When this shape is selected, the shape is formed by the five 'Custom chord' parameters, which choose the notes of the scale to use in the chord. Note that these notes are relative to the scale – for example 0, 2 & 4 define a triad of root, third, and fifth. If any of the 'Custom chord' parameters is -1, that parameter is ignored.

## **Scala and MTS support**

This algorithm's Scala and MTS (MIDI Tuning Standard) parameters are the same as those for the SD Multisample algorithm – see above.

Note that the 'Input is 12-TET' parameter lets you choose whether the input CV is working in the retuned pitch space or in 12-TET. For example, if you want to process a CV coming from a keyboard or sequencer which does not support microtuning, you will want to leave 'Input is 12-TET' at the default '1'. Only if the input CV has already had microtuning applied will you want to turn this off.

## **Input and output transposition and fine tuning**

The 'Input transpose' and 'Input tune' parameters are applied to the input CV before any further processing. Input transpose might be useful, for example, if you want to play a keyboard or sequencer in a simple key e.g. C and have the chord engine act as if you were playing in a different key. Input tune could be used, for example, if you know that your keyboard or sequencer generates CVs which are slightly off.

'Output transpose' and 'Output tune' are applied to the output CVs at the very last step of processing. They have no bearing on what notes the chord engine will generate or what chord it will make. They simply add to or subtract from the output voltages. As a simple example, you could use the transpose to shift the outputs up or down by octaves, if your VCOs require a different voltage range than the disting EX expects (which is generally 0 Volts corresponding to MIDI note 48).

## **Calibration**

This algorithm offers built-in oscillator calibration, similar to that in our Silent Way Voice Controller VST plug-in and in the FH-2 module. This is accessed from the algorithm's menu.



To calibrate an output<sup>56</sup>, connect an output from the VCO to be tuned to input 5 on the disting EX, and then choose the relevant option from the Calibrate menu. The module will output a series of voltages, ranging from -4 Volts up to +6 Volts, and analyse the pitch of the resulting signal from the VCO. As it does so, it will draw a graph of the results, which will ideally look like a nice straight line.

55 See e.g. [https://en.wikipedia.org/wiki/Minor\\_scale#Melodic\\_minor\\_scale](https://en.wikipedia.org/wiki/Minor_scale#Melodic_minor_scale)

56 We say 'calibrate an output' but what is really being calibrated is the combination of the disting EX output and the VCO. Both may in fact be perfectly well calibrated, in terms of tracking, but the absolute pitch of a VCO is usually determined by a physical tuning knob (not to mention temperature and other factors) and so is hard to know precisely. This process saves you having to tune by hand.



After calibration, the current calibration of all four voices is shown.



'Default' indicates that an output has not been calibrated and is using the default scaling (1V/octave with 0V corresponding to MIDI note 48). The vertical lines in this view indicate the current pitches/voltages of each voice.

To restore an output to the default calibration, use the 'Reset calibration' menu.



To view the output calibrations at any time, use the 'View calibrations' menu.

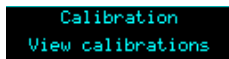

The calibrations are stored as part of the Preset.

## **MIDI output**

The notes chosen by the chord engine can be output via MIDI, according to the 'MIDI output' parameter. The possible parameter values are:

| <b>Value</b> | <b>Name</b>    | <b>Description</b>  |
|--------------|----------------|---|
| 0            | Off            | No MIDI is output.  |
| 1            | Single channel | All notes are sent on the single mode TX channel as set in the settings.  |
| 2            | Multichannel   | Notes are sent on four different MIDI channels, according to the voice. The first voice uses the channel set in the settings, the second the next highest channel, and so on. |

# 17 – Microtuner

[Video](#) 

```
17 Microtuner
7: Tuner input
0 0 Input 1
```



This algorithm is a tuner, displaying the pitch of up to four input signals at once. It can use Scala or MTS to tune to a microtonal scale.

## Algorithm-specific display

The algorithm has a special display mode which shows the tuning of the input audio. This is accessed by double-clicking the 'V' knob.

```
A 2+11 55.3Hz
33 55.0Hz
```

```
A 2+11 C 4+1
```

```
A 2+11 Bb3+15
C 4+1 -----
```

You can optionally set this mode to appear automatically when the interface is otherwise idle. Do this via the 'Auto visuals' option under the algorithm's menu. The value is a time in seconds, or zero to disable this feature.

```
Microtuner Pres
Microtuner
Microtuner Options Option
Options
Auto visuals End
Auto visuals
0
```

If you double-click 'V' to exit the visuals display mode, 'Auto visuals' will not apply until you double-click again to enter the mode.

The format of the information depends on whether the algorithm is tracking one, two or four inputs. The most information is visible when tracking a single input. Using the example above as reference, the note name and octave is displayed in large text on the left ('A 2' above). To the right of this is the deviation from the true pitch in cents ('+11' above). The deviation is also shown graphically

across the bottom of the display. At the top right of the display is the tracked pitch expressed in Hz ('55.3Hz' above). Below this is the closest note in the active scale, expressed as a note number and frequency ('33 55.0Hz' above – this is telling you that the correct pitch of A2 is 55.0Hz). Note that this depends on the chosen scale. For example, this screen:

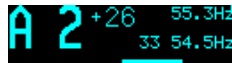

shows the same tracked pitch (55.3Hz) but since a different scale has been chosen, the correct pitch for A2 is now 54.5Hz, and the input is now 26 cents sharp, instead of 11 cents as before.

If Scala is being used to define the scale, the display also shows the tuning details of the current scale degree:



The two examples above use the same just intonation scale, but with different keyboard maps (kbn files). In the example on the left, the map is based on a root of A=440Hz, so the note E is the fifth of the scale, with a ratio of 3/2. In the example on the right, the map is based on C=261Hz, so the note E is the third, with a ratio of 5/4.

If the algorithm is unable to determine the pitch of the input signal, or if the signal falls below a threshold level, this is indicated with a row of dashes.

## Outputs

Each output can either be a copy of the correspondingly numbered input, or a fixed reference voltage (which might be useful when tuning a VCO, for example).

## Parameters

|     | Name             | Min  | Max | Default | Unit | Description  |
|-----|------------------|------|-----|---------|------|--|
| 1-6 | Attenuverter 1-6 | -200 | 200 | 100     | %    | Applies an attenuverter to the corresponding input. A negative value indicates that the CV will be inverted.   |
| 7   | Tuner input      | 0    | 10  | 0       |      | Which input or combination of inputs to tune.  |
| 8   | Scala/MTS        |      |     | 0       |      | Sets the Scala scale or MTS tuning to use.   |
| 9   | Scala KBM        |      |     | 0       |      | Sets the Scala keyboard map to use.  |
| 10  | Range            | 1    | 20  | 9       |      | Sets the range of pitches which can be tracked. Set this appropriately for the lowest note that you need to tune.  |
| 11  | Track bias       | 0    | 100 | 10      | %    | An internal parameter of the pitch tracking algorithm, which can help it avoid errors of octave in some circumstances. The default value is recommended in most cases. |
| 12  | Env threshold    | -80  | 0   | -40     | dB   | Sets a signal threshold below which no attempt is made to track pitch.   |

|    | <b>Name</b>      | <b>Min</b> | <b>Max</b> | <b>Default</b> | <b>Unit</b> | <b>Description</b>   |
|----|------------------|------------|------------|----------------|-------------|--|
| 13 | Output 1         | 0          | 1          | 0              |             | Sets what is output on output 1. The choices are 'Thru' (a straight copy of input 1) and 'Fixed V' (a fixed voltage, determined by the following parameter). |
| 14 | Output 1 voltage | -8         | 8          | 0              |             | The fixed output voltage, if the 'Output 1' parameter is set to 'Fixed V'.   |
| 15 | Output 2         | 0          | 1          | 0              |             | As above but for output 2.   |
| 16 | Output 2 voltage | -8         | 8          | 0              |             | As above but for output 2.   |
| 17 | Output 3         | 0          | 1          | 0              |             | As above but for output 3.   |
| 18 | Output 3 voltage | -8         | 8          | 0              |             | As above but for output 3.   |
| 19 | Output 4         | 0          | 1          | 0              |             | As above but for output 4.   |
| 20 | Output 4 voltage | -8         | 8          | 0              |             | As above but for output 4.   |

### ***Default mappings***

None.

### ***Scala and MTS support***

This algorithm's Scala and MTS (MIDI Tuning Standard) parameters are the same as those for the SD Multisample algorithm – see above.

## 18 – Tracker

[Video](#) 

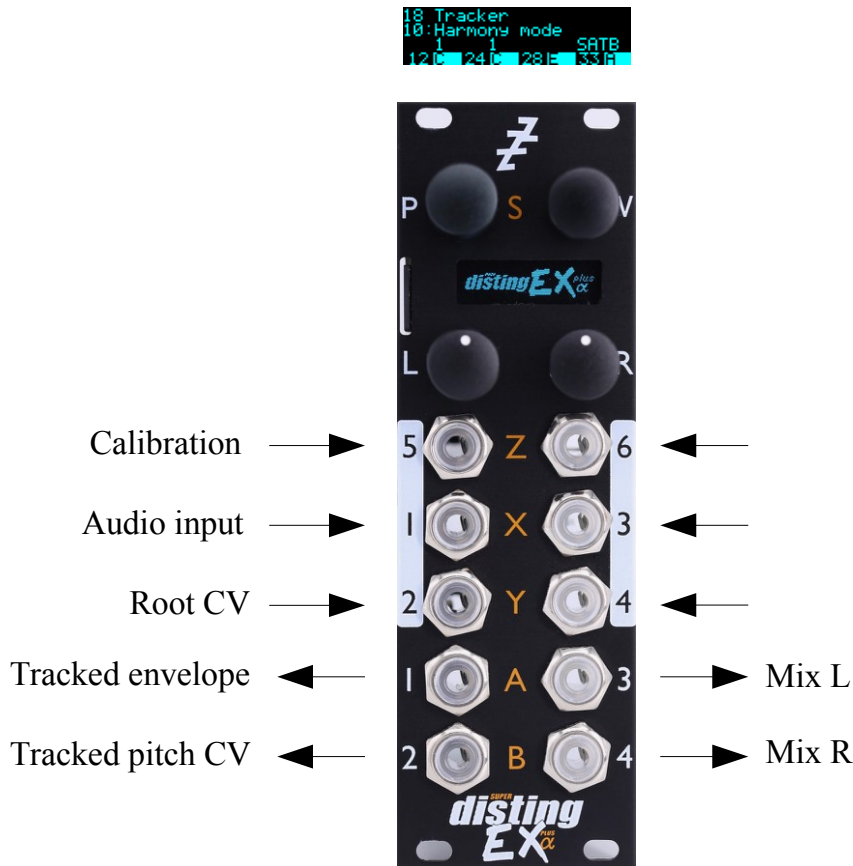

This algorithm tracks the pitch and envelope of an audio signal, and uses it to generate either CVs (of the tracked pitch and a chord related to it) or pitch-shifted versions of the input audio to form a chord.

The chords can be tuned microtonally using Scala or MTS.

There is also a built-in automatic calibration process to save having to manually tune all four possible VCOs that are under the algorithm's control.

### **Harmony modes**

There are three different ways in which the chord notes can be chosen.

The first, 'Shape mode', builds up a chord using the pitch of the input signal as the root note, according to the shape and inversion parameters. This is the same method that has been used for some time by other *disting EX* algorithms (e.g. *SD Multisample*).

The second, 'SATB mode', builds a chord according to common practice<sup>57</sup> four part harmony. (SATB stands for soprano/alto/tenor/bass.) The input signal is assigned to one of the four voices according to the 'cantus firmus' parameter, and the remaining voices fill out the chord according to the root degree and position parameters. The root can also optionally be set from a CV input or via MIDI.

Note that the root is not the same as the key. In the key of C major for example, a root degree of II

<sup>57</sup> [https://en.wikipedia.org/wiki/Common\\_practice\\_period](https://en.wikipedia.org/wiki/Common_practice_period)

gives the chord D-F-A. In the key of D major, a root degree of I gives D-F#-A.

The third mode uses incoming MIDI notes to directly specify the three harmony notes.

### Algorithm-specific display

The algorithm has a special display mode which shows the tuning of the input audio. This is accessed by double-clicking the 'V' knob.

```
110.2Hz A3+3
110.0Hz A3
```

You can optionally set this mode to appear automatically when the interface is otherwise idle. Do this via the 'Auto visuals' option under the algorithm's menu. The value is a time in seconds, or zero to disable this feature.



If you double-click 'V' to exit the visuals display mode, 'Auto visuals' will not apply until you double-click again to enter the mode.

The top line of the display shows the tracked pitch, in Hz and as a note name and octave, plus the deviation in cents. The bottom line shows the actual pitch of the nearest note in the current scale. Note that this depends on the scale, and the current microtuning (via Scala or MTS). For example, the same pitch as above but with the scale set to C natural minor shows this:

```
110.2Hz A3+3
116.5Hz Bb3
```

since the note A is not in the scale.

If the algorithm is unable to determine the pitch of the input signal, or if the signal falls below a threshold level, this is indicated with a row of dashes.

By default, a condensed version of this information is shown on the bottom line of the display:

```
18 Tracker
 9: Env. threshold
-40 -40 dB
110.7Hz A3+11
```

When the current parameter relates to the current chord, the bottom line instead shows the four notes of the current chord:

```
18 Tracker
10: Harmony mode
 1 - 1 SATB
24 C 36 C 40 E 45 B
```

### Outputs

The function of each output is set by a parameter. The choices for each output are:

| Value | Name       | Description                                      |
|-------|------------|--|
| 0     | Envelope   | The tracked volume envelope of the input signal. |
| 1     | Tracked CV | The tracked pitch CV of the input signal.        |
| 2     | Chord CV 1 | The first chord pitch CV.                        |
| 3     | Chord CV 2 | The second chord pitch CV.                       |
| 4     | Chord CV 3 | The third chord pitch CV.                        |
| 5     | Chord CV 4 | The fourth chord pitch CV.                       |
| 6     | Dry        | The dry signal i.e. the unmodified input signal. |

| Value | Name    | Description  |
|-------|---------|--|
| 7     | Shift 1 | The output of the first pitch shifter.                                     |
| 8     | Shift 2 | The output of the second pitch shifter.                                    |
| 9     | Shift 3 | The output of the third pitch shifter.                                     |
| 10    | Mix L   | The left output of a stereo mix of the dry signal and the pitch shifters.  |
| 11    | Mix R   | The right output of a stereo mix of the dry signal and the pitch shifters. |

## ***MIDI support***

This algorithm recognises note on messages.

If the harmony mode is 'MIDI', the notes are used directly for the harmony notes.

Otherwise, notes are used to set the 'Root degree' parameter. Notes C-B (in any octave) set the root degree to I-VII. Note that this always operates with C corresponding to I etc., whatever key the algorithm is actually working in.

The lowest octave (MIDI notes 0-11) additionally sets the 'Position' parameter to 'Close'; the second octave (MIDI notes 12-23) sets 'Position' to 'Open'.

Whether or not the algorithm responds to MIDI notes, and the range of notes to respond to, can be set from the algorithm's menu (in the same way as illustrated for the SD Multisample algorithm, above).

## ***Parameters***

|     | Name             | Min  | Max | Default | Unit | Description  |
|-----|------------------|------|-----|---------|------|--|
| 1-6 | Attenuverter 1-6 | -200 | 200 | 100     | %    | Applies an attenuverter to the corresponding input. A negative value indicates that the CV will be inverted.   |
| 7   | Range            | 1    | 10  | 9       |      | Sets the range of pitches which can be tracked. Set this appropriately for the lowest note that you need to track.   |
| 8   | Track bias       | 0    | 100 | 10      | %    | An internal parameter of the pitch tracking algorithm, which can help it avoid errors of octave in some circumstances. The default value is recommended in most cases. |
| 9   | Env threshold    | -80  | 0   | -40     | dB   | Sets a signal threshold below which no attempt is made to track pitch.   |
| 10  | Harmony mode     | 0    | 2   | 0       |      | Chooses the harmony mode: 'Shape', 'SATB', or 'MIDI'.  |
| 11  | Chord key        | -12  | 12  | 0       |      | The key of the chord generator. "0" is C, "1" is C#/D $\flat$ etc.   |
| 12  | Chord scale      | 0    | 8   | 0       |      | The scale of the chord generator. See above.   |
| 13  | Chord shape      | 0    | 13  | 0       |      | Shape mode: the shape of the chord generator. See above.   |



|    | Name            | Min  | Max | Default | Unit  | Description   |
|----|-----------------|------|-----|---------|-------|---|
| 14 | Chord inversion | 0    | 3   | 0       |       | Shape mode: the chord inversion. For example the first inversion takes the first note of the chord and moves it an octave up, so the lowest note in the chord is now the second (e.g. C E G becomes E G C). See e.g. <a href="#">here</a> <sup>58</sup> for a fuller explanation of inversions. |
| 15 | Root degree     | 0    | 7   | 1       |       | SATB mode: the root degree. Values of 1-7 correspond to degrees I-VII; or '0' to use the root CV input.   |
| 16 | Cantus firmus   | 0    | 3   | 3       |       | SATB mode: which voice corresponds to the input signal.   |
| 17 | Position        | 0    | 1   | 0       |       | SATB mode: Close (0) or Open (1) position.  |
| 18 | Force in tune   | 0    | 1   | 0       |       | Sets whether the chord pitches should be absolutely in tune (allowing expressive pitch bending in a solo part over a straight backing), or in tune with the tracked audio (allowing the generated chords to bend with the tracked audio).   |
| 19 | Scala/MTS       |      |     | 0       |       | Sets the Scala scale or MTS tuning to use.  |
| 20 | Scala KBM       |      |     | 0       |       | Sets the Scala keyboard map to use.   |
| 21 | Shift algorithm | 0    | 1   | 1       |       | Sets the pitch shift algorithm. The options are '2-phase' and '3-phase'.  |
| 22 | Grain size      | 1    | 340 | 300     | ms    | Sets the requested pitch shifter grain size. The actual grain sizes used by the three pitch shifters are shown on the bottom line of the display.   |
| 23 | Grain delay     | 0    | 341 | 0       | ms    | Sets the requested pitch shifter grain delay. The actual grain delays used by the three pitch shifters are shown on the bottom line of the display.   |
| 24 | Input tune      | -100 | 100 | 0       | cents | A tuning offset for the tracked pitch. This is added to the tracking result before its note (and therefore chord) is determined.  |
| 25 | Output tune     | -100 | 100 | 0       | cents | A tuning offset for the chord CV outputs.   |
| 26 | Env up slew     | 0    | 127 | 0       |       | Sets the slew time of the envelope output when the envelope is rising (range 2-1000ms).   |
| 27 | Env down slew   | -1   | 127 | -1      |       | Sets the slew time of the envelope output when the envelope is falling. The special value '-1' means 'use the same time as the up slew'.  |
| 28 | Tracked CV slew | 0    | 127 | 0       |       | Sets the slew time of the tracked pitch CV output (range 2-1000ms).   |

58 [https://en.wikipedia.org/wiki/Inversion\\_\(music\)#Inversions](https://en.wikipedia.org/wiki/Inversion_(music)#Inversions)

|       | Name              | Min  | Max | Default | Unit | Description   |
|-------|-------------------|------|-----|---------|------|---|
| 29-32 | Chord CV 1-4 slew | -1   | 127 | -1      |      | Sets the slew time of the chord pitch CV outputs. The special value '-1' means 'use the same time as the tracked pitch CV'. |
| 33    | Dry gain          | -40  | 6   | -6      | dB   | The level of the dry signal in the output mix.  |
| 34-36 | Shift 1-3 gain    | -40  | 6   | -6      | dB   | The level of the pitch shifters in the output mix.  |
| 37    | Dry pan           | -100 | 100 | 0       |      | The pan of the dry signal in the output mix.  |
| 38-40 | Shift 1-3 pan     | -100 | 100 | 0       |      | The pan of the pitch shifters in the output mix.  |
| 41    | Output 1          | 0    | 11  | 0       |      | Chooses the function of output 1. See above.  |
| 42    | Output 2          | 0    | 11  | 1       |      | Chooses the function of output 2. See above.  |
| 43    | Output 3          | 0    | 11  | 10      |      | Chooses the function of output 3. See above.  |
| 44    | Output 4          | 0    | 11  | 11      |      | Chooses the function of output 4. See above.  |
| 45    | Input gain        | 0    | 40  | 0       | dB   | The amount of gain to apply to the input.   |

## Default mappings

None.

## Scala and MTS support

This algorithm's Scala and MTS (MIDI Tuning Standard) parameters are the same as those for the SD Multisample algorithm – see above.

## Calibration

This algorithm offers built-in oscillator calibration, similar to that in our Silent Way Voice Controller VST plug-in and in the FH-2 module. This is accessed from the algorithm's menu.



To calibrate an output<sup>59</sup>, connect an output from the VCO to be tuned to input 5 on the disting EX, and then choose the relevant option from the Calibrate menu. The module will output a series of voltages, ranging from -4 Volts up to +6 Volts, and analyse the pitch of the resulting signal from the VCO. As it does so, it will draw a graph of the results, which will ideally look like a nice straight line.



After calibration, the current calibration of all four voices is shown.



'Default' indicates that an output has not been calibrated and is using the default scaling (1V/octave with 0V corresponding to MIDI note 48). The vertical lines in this view indicate the current

<sup>59</sup> We say 'calibrate an output' but what is really being calibrated is the combination of the disting EX output and the VCO. Both may in fact be perfectly well calibrated, in terms of tracking, but the absolute pitch of a VCO is usually determined by a physical tuning knob (not to mention temperature and other factors) and so is hard to know precisely. This process saves you having to tune by hand.

pitches/voltages of each voice.

To restore an output to the default calibration, use the 'Reset calibration' menu.



To view the output calibrations at any time, use the 'View calibrations' menu.

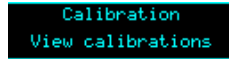

The calibrations are stored as part of the Preset.

## 19 – Macro Oscillator

[Video](#) 

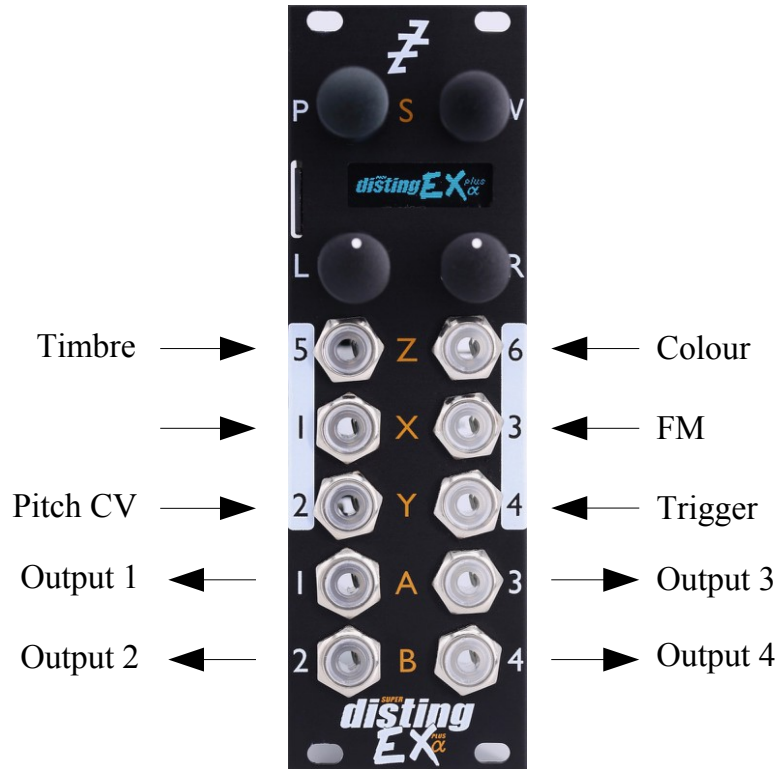
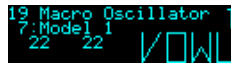

This algorithm is an implementation of the open source [Braids](#)<sup>60</sup> module by Émilie Gillet. It provides four independent instances of the module, each with its own output. The *disting EX*'s inputs can be freely assigned to any or all of the instances. Control via MIDI is also possible, making this an excellent application for the [CVM-8](#)<sup>61</sup> module to provide, say, separate trigger inputs for all four instances.

Over MIDI or I2C the algorithm supports round-robin polyphonic voice allocation, allowing you to play the four oscillators as a polyphonic synthesizer – with the same, or different, settings for each voice.

Happily the original code was designed to run at 96kHz, as does the *disting EX*, so this implementation should behave and sound identical to the original. Any demos or tutorials you may find online should apply just as well to this version. The user manual for the original module is [here](#)<sup>62</sup>. The documentation below assumes some familiarity with this.

### ***META mode***

The original *Braids* has a separate mode in which the FM CV controls the choice of synthesis model. The *disting EX* doesn't require a special mode for this since you can use CV Mappings to control the model parameters however you like.

60 <https://github.com/pichenettes/eurorack/tree/master/braids>

61 <https://expert-sleepers.co.uk/cvm8.html>

62 <https://pichenettes.github.io/mutable-instruments-documentation/modules/braids/manual/>

## Outputs



A full matrix mixer is provided to flexibly assign the four macro oscillators to the disting EX's four outputs. This is accessed through the algorithm's menu.

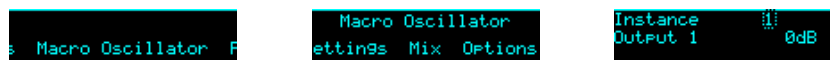

While in this menu, turning the left (P) encoder moves the highlight rectangle, and turning the right (V) encoder changes the item under the highlight.

By default, each macro oscillator has its own dedicated output.

## MIDI support

This algorithm recognises note on messages, which can be used to set the macro oscillator pitch and/or trigger the AD envelopes. See the settings, below.

Whether or not the algorithm responds to MIDI notes, and the range of notes to respond to, can be set from the algorithm's menu (in the same way as illustrated for the SD Multisample algorithm, above).

## Parameters

|     | Name             | Min  | Max  | Default | Unit  | Description  |
|-----|------------------|------|------|---------|-------|--|
| 1-6 | Attenuverter 1-6 | -200 | 200  | 100     | %     | Applies an attenuverter to the corresponding input. A negative value indicates that the CV will be inverted. |
| 7   | Model 1          | 0    | 46   | 0       |       | Chooses the synthesis model for macro oscillator 1.  |
| 8   | Timbre 1         | 0    | 1024 | 0       |       | Sets the timbre control for macro oscillator 1.  |
| 9   | Colour 1         | 0    | 1024 | 0       |       | Sets the colour control for macro oscillator 1.  |
| 10  | AD Attack 1      | 0    | 15   | 0       |       | Sets the envelope attack time for macro oscillator 1.  |
| 11  | AD Decay 1       | 0    | 15   | 5       |       | Sets the envelope decay time for macro oscillator 1.   |
| 12  | AD FM 1          | 0    | 15   | 0       |       | Sets the amount by which the envelope affects the FM for macro oscillator 1.                                 |
| 13  | AD Timbre 1      | 0    | 15   | 0       |       | Sets the amount by which the envelope affects the timbre for macro oscillator 1.                             |
| 14  | AD Colour 1      | 0    | 15   | 0       |       | Sets the amount by which the envelope affects the colour for macro oscillator 1.                             |
| 15  | AD VCA 1         | 0    | 1    | 0       |       | Sets whether the envelope is applied to the volume of the output for macro oscillator 1.                     |
| 16  | Coarse 1         | -48  | 48   | 0       | ST    | Coarse tuning control for macro oscillator 1.  |
| 17  | Fine 1           | -100 | 100  | 0       | cents | Fine tuning control for macro oscillator 1.  |

|       | Name             | Min | Max | Default | Unit | Description  |
|-------|------------------|-----|-----|---------|------|--|
| 18    | Scale 1          | 0   | 48  | 0       |      | Sets the quantizer scale for macro oscillator 1.                               |
| 19    | Root 1           | 0   | 11  | 0       |      | Sets the quantizer root note for macro oscillator 1.                           |
| 20-32 |                  |     |     |         |      | As above, for macro oscillator 2.  |
| 33-45 |                  |     |     |         |      | As above, for macro oscillator 3.  |
| 46-58 |                  |     |     |         |      | As above, for macro oscillator 4.  |
| 59    | Resolution 1     | 0   | 6   | 6       |      | Sets the output bit depth for macro oscillator 1.                              |
| 60    | Sample rate 1    | 0   | 6   | 6       |      | Sets the output sample rate for macro oscillator 1.                            |
| 61    | Trigger source 1 | 0   | 1   | 0       |      | If '1', enables automatic triggering on pitch changes, for macro oscillator 1. |
| 62    | Trigger delay 1  | 0   | 6   | 1       |      | Sets the trigger delay for macro oscillator 1.                                 |
| 63-66 |                  |     |     |         |      | As above, for macro oscillator 2.  |
| 67-70 |                  |     |     |         |      | As above, for macro oscillator 3.  |
| 71-74 |                  |     |     |         |      | As above, for macro oscillator 4.  |

## Default mappings

None.

## Settings

As on the original Braids, a number of parameters are hidden behind an obscure menu system. These are accessed from the module's menu:

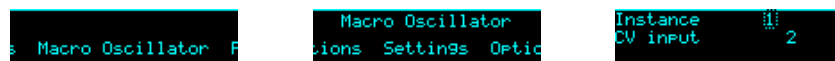

While in this menu, turning the left (P) encoder moves the highlight rectangle, and turning the right (V) encoder changes the item under the highlight. For each macro oscillator instance, the following settings are available.

| Name          | Min | Max | Default | Description   |
|---------------|-----|-----|---------|---|
| CV input      | 0   | 6   | 2       | Selects which input is used as the pitch CV input, or '0' for 'None'. |
| FM input      | 0   | 6   | 3       | Selects which input is used as the FM input, or '0' for 'None'.       |
| Trigger input | 0   | 6   | 4       | Selects which input is used as the trigger input, or '0' for 'None'.  |
| Timbre input  | 0   | 6   | 5       | Selects which input is used as the timbre input, or '0' for 'None'.   |
| Colour input  | 0   | 6   | 6       | Selects which input is used as the colour input, or '0' for 'None'.   |

| Name           | Min | Max | Default | Description  |
|----------------|-----|-----|---------|--|
| Flatten        | 0   | 1   | 0       | “applies a detuning in the lower and higher frequencies, to recreate some of the tuning imperfections of VCOs.” <sup>63</sup>  |
| Drift          | 0   | 4   | 0       | “recreates the drifting of a disastrously designed VCO.”   |
| Signature      | 0   | 4   | 0       | “applies grungy glitches/waveform imperfections to the output signal. The exact behavior of this option is unique to each module built.”   |
| MIDI option    | 0   | 144 | 0       | Selects how the macro oscillator will use MIDI.  |
| Share settings | 1   | 4   |         | Sets which set of settings the macro oscillator will use, allowing you to share settings between oscillators (for convenience when you want multiple oscillators to sound the same). Applies to all settings and parameters with the exception of the CV and Trigger input settings. |

The choices for the MIDI option setting are as follows. In all cases the “base MIDI channel” refers to that set in the global module Settings (below).

| Value   | Name                    | Description  |
|---------|-------------------------|--|
| 0       | Off                     | The macro oscillator will not use MIDI.  |
| 1-4     | Pitch from ch+0/1/2/3   | The macro oscillator will take its pitch from MIDI notes on the base MIDI channel plus the indicated number.   |
| 5-8     | Pitch/trig ch+0/1/2/3   | The macro oscillator will take its pitch from, and its envelope will be triggered by, MIDI notes on the base MIDI channel plus the indicated number.   |
| 9-12    | Trigger from ch+0/1/2/3 | The macro oscillator's envelope will be triggered by MIDI notes on the base MIDI channel plus the indicated number.  |
| 13-140  | Trig by note 0-127      | The macro oscillator's envelope will be triggered by the specified note (only) on the base MIDI channel.   |
| 141-144 | Poly ch+0/1/2/3         | The macro oscillator is placed in a group with other oscillators with the same MIDI option, and round-robin polyphonic voice allocation performed to distribute MIDI notes among the voices. MIDI notes are used for both pitch and trigger. |

<sup>63</sup> This and following quotes from the Braids manual: <https://pichenettes.github.io/mutable-instruments-documentation/modules/braids/manual/>

## 20 – Resonator

[Video](#) 

```
20 Resonator
7: Mode
1 1 Sympathetic
```

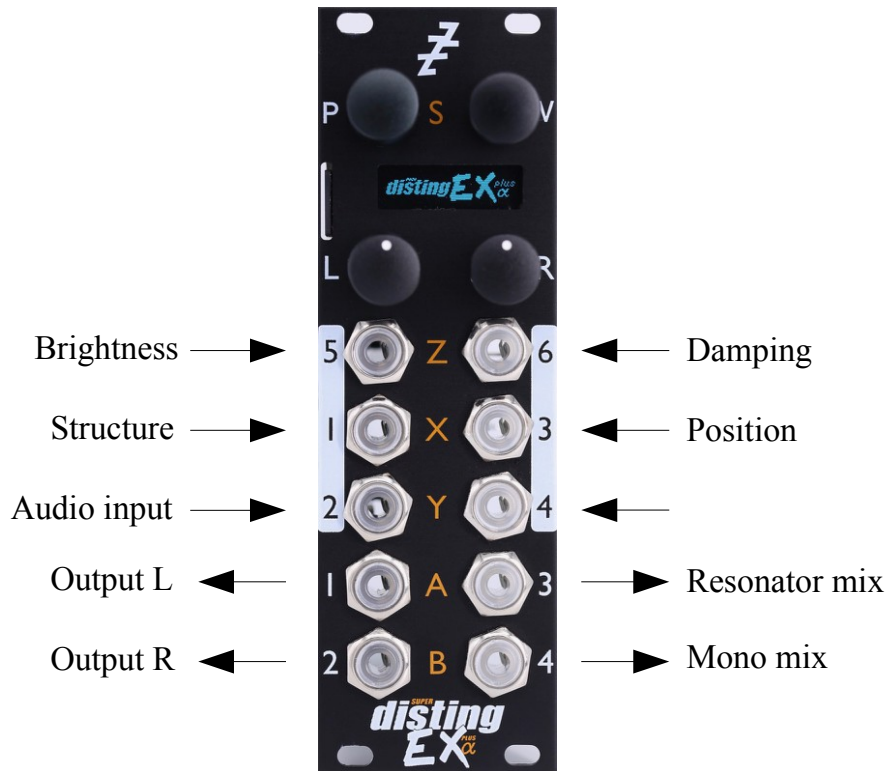

This algorithm is an implementation of the open source [Rings](#)<sup>64</sup> module by Émilie Gillet.

Building on the features of the original module, this algorithm also provides a flexible stereo output mix of the 'odd' and 'even' Rings outputs and of the dry signal.

The algorithm can be played via MIDI or I2C, or simply via CV/gate as the original.

Any demos or tutorials you may find online should apply just as well to this implementation. The user manual for the original module is [here](#)<sup>65</sup>. The documentation below assumes some familiarity with this.

### ***Input normalization***

The original Rings module made extensive use of detecting which inputs had jacks plugged in and adjusting its behaviour accordingly. For example, if nothing is plugged into the Strum input, the module generates strums internally from pitch changes or audio transients.

The *disting EX* has no way of knowing whether its sockets are connected or not, so this algorithm relies on the various 'input' parameters being set to zero or not. To take the same example, if the 'Strum input' parameter is set to zero, the algorithm will generate its own strums; if the parameter is non-zero, the algorithm assumes you're going to supply strums on the input you choose.

64 <https://github.com/pichenettes/eurorack/tree/master/rings>

65 <https://pichenettes.github.io/mutable-instruments-documentation/modules/rings/manual/>



## Outputs

Outputs 1 & 2 provide a stereo mix of the resonator outputs and the dry signal, according to the 'Output gain', 'Dry gain', 'Odd pan', 'Even pan', and 'Dry pan' parameters.

Output 3 provides a simple mix of the resonator odd and even outputs.

Output 4 provides a mono mix of the stereo output.

## MIDI support

This algorithm recognises note on messages, which can be used to set the pitch and/or provide the strum, according to the 'MIDI mode' parameter.

Whether or not the algorithm responds to MIDI notes, and the range of notes to respond to, can be set from the algorithm's menu (in the same way as illustrated for the SD Multisample algorithm, above).

## Parameters

|     | Name             | Min  | Max | Default | Unit  | Description  |
|-----|------------------|------|-----|---------|-------|--|
| 1-6 | Attenuverter 1-6 | -200 | 200 | 100     | %     | Applies an attenuverter to the corresponding input. A negative value indicates that the CV will be inverted. |
| 7   | Mode             | 0    | 6   | 0       |       | Selects the resonator mode.  |
| 8   | Synth effect     | 0    | 5   | 0       |       | If the mode is 'Synth', selects the audio effect applied to the synth output.                                |
| 9   | Polyphony        | 1    | 4   | 1       |       | Sets the number of simultaneous voices.  |
| 10  | Coarse tune      | -60  | 60  | 0       | ST    | Provides a coarse tuning control.  |
| 11  | Fine tune        | -100 | 100 | 0       | cents | Provides a fine tuning control.  |
| 12  | Structure        | 0    | 127 | 64      |       | Controls the resonator 'structure'.  |
| 13  | Brightness       | 0    | 127 | 64      |       | Controls the resonator 'brightness'.   |
| 14  | Damping          | 0    | 127 | 64      |       | Controls the resonator 'damping'.  |
| 15  | Position         | 0    | 127 | 64      |       | Controls the resonator 'position'.   |
| 16  | Chord            | 0    | 10  | 0       |       | Chooses the chord to use for resonator modes that use one. In the original, set from the Structure knob.     |
| 17  | Noise gate       | 0    | 1   | 1       |       | Enables a noise gate on the audio input. Always enabled in the original Rings.                               |
| 18  | Input gain       | -40  | 12  | 0       | dB    | A gain applied to the input audio, before it hits the resonator.   |
| 19  | Output gain      | -40  | 12  | 0       | dB    | Level of the resonator outputs in the stereo mix. '-40' is treated as $-\infty$ dB.                          |
| 20  | Dry gain         | -40  | 12  | 0       | dB    | Level of the dry signal in the stereo mix. '-40' is treated as $-\infty$ dB.                                 |
| 21  | Odd pan          | -100 | 100 | -100    | %     | Pan position of the resonator 'odd' output.  |

|    | <b>Name</b>      | <b>Min</b> | <b>Max</b> | <b>Default</b> | <b>Unit</b> | <b>Description</b>                                    |
|----|------------------|------------|------------|----------------|-------------|---|
| 22 | Even pan         | -100       | 100        | 100            | %           | Pan position of the resonator 'even' output.          |
| 23 | Dry pan          | -100       | 100        | 0              | %           | Pan position of the dry signal.                       |
| 24 | Strum input      | 0          | 6          | 0              |             | Chooses which input to use for 'strum'.               |
| 25 | V/Oct input      | 0          | 6          | 0              |             | Chooses which input to use for the V/octave pitch CV. |
| 26 | Audio input      | 0          | 6          | 2              |             | Chooses which input to use for the audio input.       |
| 27 | Brightness input | 0          | 6          | 5              |             | Chooses which input to use for 'brightness'.          |
| 28 | Frequency input  | 0          | 6          | 0              |             | Chooses which input to use for 'frequency'.           |
| 29 | Damping input    | 0          | 6          | 6              |             | Chooses which input to use for 'damping'.             |
| 30 | Structure input  | 0          | 6          | 1              |             | Chooses which input to use for 'structure'.           |
| 31 | Position input   | 0          | 6          | 3              |             | Chooses which input to use for 'position'.            |
| 32 | MIDI mode        | 0          | 3          | 0              |             | Controls the algorithm's response to MIDI. See below. |
| 33 | I2C mode         | 0          | 3          | 0              |             | Controls the algorithm's response to I2C. See below.  |

### ***Default mappings***

None.

### ***MIDI and I2C modes***

The MIDI mode and I2C mode parameters allow you to choose how MIDI and I2C will be used. Both have the same options:

| <b>Value</b> | <b>Name</b>   | <b>Description</b>                                   |
|--------------|---------------|--|
| 0            | Off           | Notes will not be used.                              |
| 1            | Pitch         | Note on events will set the pitch.                   |
| 2            | Strum         | Note on events will cause a strum.                   |
| 3            | Pitch & strum | Note on events will set the pitch and cause a strum. |

Note that in terms of the input normalization logic described above, activating MIDI or I2C for pitch and/or strum is taken to be equivalent to connecting a CV input for that parameter. E.g. setting the MIDI mode to 'Strum' will stop the algorithm generating its own strums internally.

## 21 – Macro Oscillator 2

[Video](#) 

```
21 Macro Osc 2 4
40 Model 4 4
7 7 Speech
```

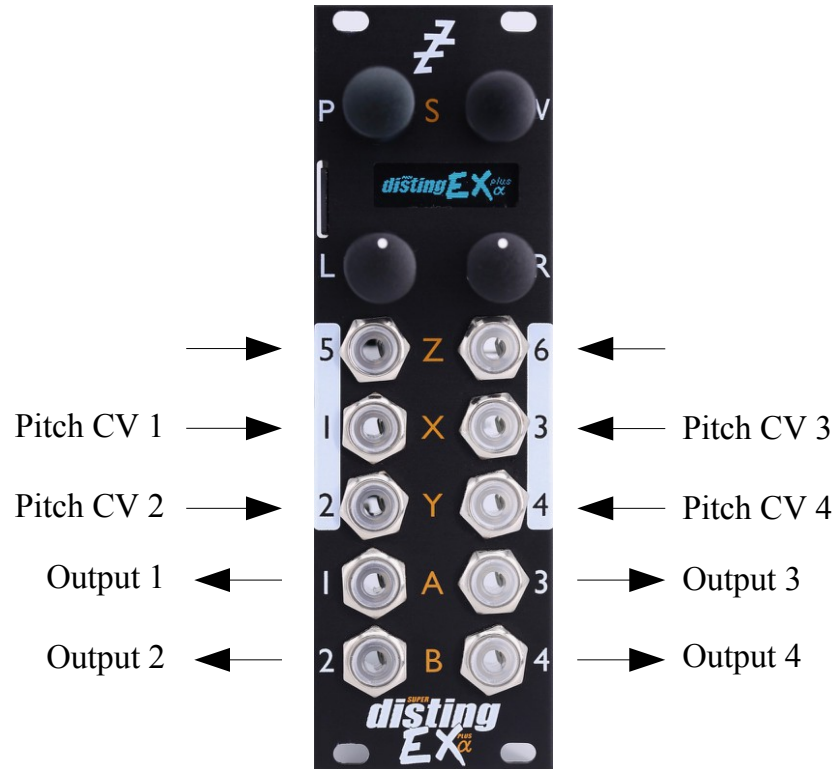

This algorithm is an implementation of the open source [Plaits](#)<sup>66</sup> module by Émilie Gillet. It provides four independent instances of the module. The **disting EX**'s inputs can be freely assigned to any or all of the instances. Control via MIDI is also possible, making this an excellent application for the [CVM-8](#)<sup>67</sup> module to provide, say, separate trigger inputs for all four instances.

Over MIDI or I2C the algorithm supports round-robin polyphonic voice allocation, allowing you to play the four oscillators as a polyphonic synthesizer – with the same, or different, settings for each voice.

This implementation should behave and sound identical to the original. Any demos or tutorials you may find online should apply just as well to this version. The user manual for the original module is [here](#)<sup>68</sup>. The documentation below assumes some familiarity with this.

### **Input normalization**

The original Plaits module made extensive use of detecting which inputs had jacks plugged in and adjusting its behaviour accordingly. For example, if nothing is plugged into the Trigger input, the envelope is not used and the module constantly emits sound.

The **disting EX** has no way of knowing whether its sockets are connected or not, so this algorithm relies on the various 'input' settings being set to zero or not. To take the same example, if the

<sup>66</sup> <https://github.com/pichenettes/eurorack/tree/master/plaits>

<sup>67</sup> <https://expert-sleepers.co.uk/cvm8.html>

<sup>68</sup> <https://pichenettes.github.io/mutable-instruments-documentation/modules/plaits/manual/>

'Trigger input' setting is set to zero, the algorithm will generate constant sound; if the setting is non-zero, the algorithm assumes you're going to supply triggers on the input you choose.

## Outputs

There are two output modes: either all four instances are mixed, or each output can be assigned individually.

In the mixed mode, output 1 carries a mix of the main outputs of all four instances, and output 2 carries a mix of the aux outputs of all four instances. Outputs 3 & 4 are duplicates of outputs 1 & 2.

In the individual mode, each of the disting's four outputs can be assigned to the main or aux output of one instance.

In either case, the output key display (hold and turn 'V') is a convenient reminder of the outputs:



## MIDI support

This algorithm recognises note on messages, which can be used to set the macro oscillator pitch and/or trigger the envelopes/LPGs.

Though not a feature of the original module, when triggered via MIDI (or I2C) this algorithm offers velocity sensitivity. Note velocity is mapped either to the LPG (if the model uses it) or the accent (if available, for example in the drum models).

Whether or not the algorithm responds to MIDI notes, and the range of notes to respond to, can be set from the algorithm's menu (in the same way as illustrated for the SD Multisample algorithm, above).

## Parameters

|     | Name             | Min  | Max | Default | Unit  | Description  |
|-----|------------------|------|-----|---------|-------|--|
| 1-6 | Attenuverter 1-6 | -200 | 200 | 100     | %     | Applies an attenuverter to the corresponding input. A negative value indicates that the CV will be inverted. |
| 7   | Model 1          | 0    | 15  | 0       |       | Chooses the synthesis model for macro oscillator 1.  |
| 8   | Coarse tune 1    | -60  | 60  | 0       | ST    | Coarse tuning control for macro oscillator 1.  |
| 9   | Fine tune 1      | -100 | 100 | 0       | cents | Fine tuning control for macro oscillator 1.  |
| 10  | Harmonics 1      | 0    | 127 | 64      |       | Sets the harmonics control for macro oscillator 1.   |
| 11  | Timbre 1         | 0    | 127 | 64      |       | Sets the timbre control for macro oscillator 1.  |
| 12  | Morph 1          | 0    | 127 | 64      |       | Sets the morph control for macro oscillator 1.   |
| 13  | FM 1             | -100 | 100 | 0       | %     | Sets the FM depth for macro oscillator 1.  |
| 14  | Timbre mod 1     | -100 | 100 | 0       | %     | Sets the timbre modulation depth for macro oscillator 1.   |

|       | Name            | Min  | Max | Default | Unit | Description   |
|-------|-----------------|------|-----|---------|------|---|
| 15    | Morph mod 1     | -100 | 100 | 0       | %    | Sets the morph modulation depth for macro oscillator 1.                   |
| 16    | Low-pass gate 1 | 0    | 127 | 127     |      | Sets the LPG colour (VCFA-VCA blend) for macro oscillator 1.              |
| 17    | Time/decay 1    | 0    | 127 | 64      |      | Sets the envelope decay time for macro oscillator 1.                      |
| 18-28 |                 |      |     |         |      | As above, for macro oscillator 2.   |
| 29-39 |                 |      |     |         |      | As above, for macro oscillator 3.   |
| 40-50 |                 |      |     |         |      | As above, for macro oscillator 4.   |
| 51    | Output 1 gain   | -40  | 6   | 0       | dB   | Gain control for output 1. '-40' is treated as $-\infty$ dB.              |
| 52    | Output 2 gain   | -40  | 6   | 0       | dB   | Gain control for output 2. '-40' is treated as $-\infty$ dB.              |
| 53    | Output 3 gain   | -40  | 6   | 0       | dB   | Gain control for output 3. '-40' is treated as $-\infty$ dB.              |
| 54    | Output 4 gain   | -40  | 6   | 0       | dB   | Gain control for output 4. '-40' is treated as $-\infty$ dB.              |
| 65    | Output mode     | 0    | 1   | 0       |      | Sets the output mode. See above.  |
| 66    | Output 1        | 0    | 7   | 0       |      | If the output mode is 'Individual', chooses what is assigned to output 1. |
| 67    | Output 2        | 0    | 7   | 2       |      | As above for output 2.  |
| 68    | Output 3        | 0    | 7   | 4       |      | As above for output 3.  |
| 69    | Output 4        | 0    | 7   | 6       |      | As above for output 4.  |

## Default mappings

None.

## Settings

A number of configuration settings (mostly, choosing which inputs are used by each instance) are accessed from the module's menu:

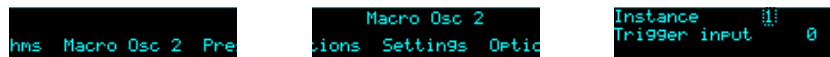

While in this menu, turning the left (P) encoder moves the highlight rectangle, and turning the right (V) encoder changes the item under the highlight. For each macro oscillator instance, the following settings are available.

| Name          | Min | Max | Default | Description  |
|---------------|-----|-----|---------|--|
| Trigger input | 0   | 6   | 0       | Selects which input is used as the trigger input, or '0' for 'None'. |

| <b>Name</b>     | <b>Min</b> | <b>Max</b> | <b>Default</b> | <b>Description</b>  |
|-----------------|------------|------------|----------------|---|
| Level input     | 0          | 6          | 0              | Selects which input is used as the level input, or '0' for 'None'.  |
| CV input        | 0          | 6          | 1/2/3/4        | Selects which input is used as the pitch CV input, or '0' for 'None'.   |
| FM input        | 0          | 6          | 0              | Selects which input is used as the FM input, or '0' for 'None'.   |
| Harmonics input | 0          | 6          | 0              | Selects which input is used as the harmonics input, or '0' for 'None'.  |
| Timbre input    | 0          | 6          | 0              | Selects which input is used as the timbre input, or '0' for 'None'.   |
| Morph input     | 0          | 6          | 0              | Selects which input is used as the morph input, or '0' for 'None'.  |
| MIDI option     | 0          | 144        | 0              | Selects how the macro oscillator will use MIDI.   |
| I2C trigger     | 0          | 1          | 0              | If '1', I2C messages are treated as a source of triggers.   |
| Share params    | 1          | 4          | 1/2/3/4        | Sets which set of parameters and settings the macro oscillator will use, allowing you to share settings between oscillators (for convenience when you want multiple oscillators to sound the same). Applies to all settings and parameters with the exception of the CV and Trigger input settings. |

The choices for the MIDI option setting are the same as those for the Macro Oscillator algorithm – see above.

## Dual Mode Algorithms

The following pages describe the disting EX's “dual mode” algorithms that are not also algorithms on the disting mk4.

### H-2 Dual Sample and Hold<sup>69</sup>

[Video](#) 

**A = X when Z exceeds 1V**  
**B = Y when Z exceeds 1V**

**OR**

**A = Z when X exceeds 1V**  
**B = Z when Y exceeds 1V**

| Parameter | Min | Max | Default | Description |
|-----------|-----|-----|---------|-------------|
| 0         | 0   | 5   | 0       | Mode.       |
| 1         | 0   | 31  | 0       | Offset.     |
| 2         | 0   | 64  | 0       | Noise X.    |
| 3         | 0   | 64  | 0       | Noise Y.    |
| 4         | 0   | 32  | 0       | Slew A.     |
| 5         | 0   | 32  | 0       | Slew B.     |

This algorithm implements two variations on dual “sample and hold” or “track and hold” - either X & Y are the inputs, sampled when triggered by Z, or Z is the input, sampled when triggered by X or Y. In all cases the trigger threshold is 1V.

“Sample and hold” means a sample is taken at the instant that the trigger goes high and held until the next trigger. “Track and hold” means the output follows the input while the trigger is high, and is locked when the trigger goes low.

| Parameter 0 value | Mode                                      |
|-------------------|---|
| 0                 | X & Y inputs; sample and hold.            |
| 1                 | X & Y inputs; track and hold.             |
| 2                 | Z input (including pot); sample and hold. |
| 3                 | Z input (including pot); track and hold.  |
| 4                 | Z input (excluding pot); sample and hold. |
| 5                 | Z input ( excluding pot); track and hold. |

Similarly for output B/input Y.

Pressing the Z knob triggers a sample manually.

Parameter 1 sets an offset between the timing of the X/Y & Z inputs (in sample frames). If X/Y & Z are being driven together, for example by a sequencer's pitch and gate, it is often a good idea to delay the trigger slightly to allow time for the sampled CV to settle before the sample is taken.

<sup>69</sup> While this is in fact a disting mk4 algorithm, the disting EX version is different enough that we felt that completely new documentation would be clearer.

If X & Y are the inputs, parameters 2 & 3 add white noise into the signal from inputs X & Y respectively, allowing you to use the algorithm as a source of random voltages without having to patch anything into the inputs. Similarly, if Z is the input, parameter 2 adds white noise into Z.

Parameters 4 & 5 control the amount of slew applied to outputs A & B respectively.

## J-5 Oscilloscope

[Video](#) 

**X & Y are signal inputs**  
**Z is trigger threshold**  
**A & B mirror X & Y**

| Parameter | Min | Max | Default | Description      |
|-----------|-----|-----|---------|------------------|
| 0         | 0   | 4   | 0       | Display mode.    |
| 1         | -10 | 10  | -10     | Minimum voltage. |
| 2         | -10 | 10  | 10      | Maximum voltage. |
| 3         | 0   | 13  | 8       | Timescale.       |
| 4         | 0   | 4   | 0       | Trigger mode.    |
| 5         | 0   | 1   | 0       | Drawing mode.    |

This algorithm implements a simple but useful 2-channel oscilloscope.

X & Y are the two signal inputs. They are passed through unmodified to A & B.

Parameter 0 sets the display mode. The options are

- Overlaid: X & Y are drawn over each other.
- Stacked: X & Y each get half the screen.
- Only X/Only Y: one signal only is drawn.
- X-Y: X & Y are used as the coordinates to draw, instead of using time as the abscissa.

Parameters 1 & 2 set the minimum and maximum voltages for the signal inputs.

Parameter 3 sets the time corresponding to the full width of the view. A value of '0' causes the timescale to be set automatically to the time between triggers.

Parameter 4 sets the trigger mode. The options are

- Free running: the display is continuously updated.
- X rising: the display is triggered by a rising edge on X.
- X falling: the display is triggered by a falling edge on X.
- Y rising: the display is triggered by a rising edge on Y.
- Y falling: the display is triggered by a falling edge on Y.

In the triggered modes, the trigger level is set by the Z pot/CV.

Parameter 5 sets the drawing mode, to 'Lines' or 'Points'.



## K-6 24dB/oct VCF

[Video](#) 

**X is audio input**  
**Y is cutoff**  
**Z is resonance**  
**A & B are output**

| Parameter | Min | Max | Default | Description     |
|-----------|-----|-----|---------|-----------------|
| 0         | -80 | 80  | 0       | Y offset.       |
| 1         | -64 | 64  | 64      | Y attenuverter. |
| 2         | -12 | 48  | 0       | Drive.          |
| 3         | 0   | 1   | 1       | Normalize.      |

This algorithm is a 24dB/octave lowpass filter, implemented using circuit emulation of a four pole transistor ladder filter<sup>70</sup>.

X is the audio input; A & B are both the audio output.

Y is the cutoff frequency CV, with a 1V/octave response. The cutoff can be offset or set manually using parameter 0 (which is scaled as 1/16<sup>th</sup> of a Volt per unit).

The Z knob/CV controls the filter resonance. The filter will self-oscillate at high resonances.

Parameter 1 is an attenuverter for the Y input.

Parameter 2 sets an input gain in dB.

Parameter 3 enables 'normalize', which boosts the gain to compensate for the natural tendency of the circuit to lose low-frequency level as the resonance is increased.

## K-7 Delay Stereo

Has exactly the same functionality and parameters as the disting mk4's 'Stereo Clockable SD Delay' except that it does not use the MicroSD card and has a maximum delay time of 10.9 seconds.

## K-8 Delay Stereo Clk

Has exactly the same functionality and parameters as the disting mk4's 'Stereo Clockable SD Delay (Z clock)' except that it does not use the MicroSD card and has a maximum delay time of 10.9 seconds.

---

<sup>70</sup> Developed using hard sums by Eddie Edwards at Reanimator Ltd – see Acknowledgments, below.

## N-7 Frequency Shifter<sup>71</sup>

[Video](#) 

X & Y are signal inputs  
Z is frequency shift or attenuator  
A & B are signal outputs

| Parameter | Min | Max | Default | Description  |
|-----------|-----|-----|---------|--------------|
| 0         | 0   | 4   | 0       | Mode.        |
| 1         | 0   | 3   | 1       | Range.       |
| 2         | 0   | 1   | 1       | Include pot. |
| 3         | -32 | 32  | -32     | Mix.         |
| 4         | -31 | 31  | 0       | Feedback.    |
| 5         | 0   | 99  | 0       | Delay.       |

This algorithm is a stereo frequency shifter, which can also be a Single-Side-Band (SSB) modulator.

X and Y are the audio inputs. A and B are the audio outputs.

Parameter 0 sets the mode of operation - frequency shifter (modes 0-3) or SSB modulator (mode 4).

### When in frequency shifter mode:

The Z knob/CV controls the frequency shift. Parameter 1 sets the range of the Z CV, from 1Hz/Volt up to 1kHz/Volt. Parameter 2 controls whether the Z CV is derived from the sum of the input CV and the pot (which is usual disting mk4 and dual mode behaviour) or just from the input CV, ignoring the pot. This makes it easier to set precise shifts without worrying about the position of the pot.

The mode also controls whether output B uses the same shift as output A (modes 0 & 2) or the opposite shift (modes 1 & 3). Small opposite shifts can give a pleasing chorus type sound. This also allows for the possibility of shifting the frequency, processing the shifted sound, and returning it to the other channel to be shifted back to its original frequency.

Modes 2 & 3 sum the input signals to mono before frequency shifting.

### When in SSB modulator mode:

Inputs X & Y are modulated with each other. Output A gives the upper side band, and output B gives the lower side band. In this mode, Z is used as an attenuator (with 5V, or full turn on the knob, giving unity gain). Note that because Z can be bipolar, you can actually use it to ring-modulate the SSB modulator outputs.

In SSB modulator mode parameter 1 (Range) is not used.

If you use a pure sine wave for input X or Y, you essentially have a frequency shifter, but one where you control the shift by controlling your input oscillator.

### In all modes:

Parameter 3 allows you to blend the output between the shifted and original audio. At zero, the output is 100% dry i.e. the input signal with no frequency shifted signal added. For positive parameter values, the frequency shifted signal is added while holding the dry level constant. For

<sup>71</sup> While this is in fact a disting mk4 algorithm, the disting EX version is different enough that we felt that completely new documentation would be clearer.

negative parameter values, the dry and frequency shifted signals are progressively crossfaded, until eventually the output is 100% wet i.e. just the frequency shifted signal.

Parameters 4 & 5 control a feedback loop around the frequency shifters. Parameter 4 controls the feedback (which can be negative) and parameter 5 sets the delay time of the loop (with a maximum of around 170ms).

## N-8 Dual VCO

[Video](#) 

**X is V/Oct pitch input 1**  
**Y is V/Oct pitch input 2**  
**Z is wavetable position**  
**A is wavetable output 1**  
**B is wavetable output 2**

**Receives MIDI**

| Parameter | Min | Max | Default | Description            |
|-----------|-----|-----|---------|------------------------|
| 0         | 0   | 99  | 0       | Chooses the wavetable. |
| 1         | -32 | 32  | 0       | Offset A.              |
| 2         | -32 | 32  | 0       | Offset B.              |
| 3         | -64 | 64  | 0       | Coarse A.              |
| 4         | -64 | 64  | 0       | Coarse B.              |
| 5         | -50 | 50  | 0       | Fine A.                |
| 6         | -50 | 50  | 0       | Fine B.                |
| 7         | -64 | 64  | 64      | Z attenuverter.        |

This algorithm is a dual wavetable VCO. See for example [here](#)<sup>72</sup> for a brief overview of wavetable synthesis.

X and Y are the pitch inputs for the VCOs, with a 1V/octave response. The 0V point for the pitch input is C3 (approximately 130.81Hz).

A and B are the corresponding VCO outputs.

Parameter 0 chooses the wavetable.

The Z knob/CV controls the lookup point in the wavetable. Parameter 7 is an attenuverter for Z.

Parameters 1 & 2 offset the lookup point for the two VCOs (added to Z).

Parameters 3 & 4 are coarse tuning controls for the VCOs (in semitones); parameters 5 & 6 are fine tuning controls (in cents).

<sup>72</sup> [https://en.wikipedia.org/wiki/Wavetable\\_synthesis](https://en.wikipedia.org/wiki/Wavetable_synthesis)

## WAV file naming conventions and playlists

The disting EX supports WAV file playlists exactly as documented for the disting mk4. However, it also supports naming conventions to set the most commonly used settings without requiring a playlist. Some of these naming conventions set features not available on the mk4 e.g. round robins. Look in the folders on the MicroSD card that is supplied with the module for some examples.

| Key                                  | Example                        | Playlist flag | Description  |
|--------------------------------------|--------------------------------|---------------|--|
| _ <code>&lt;note name&gt;</code>     | piano_A2.wav<br>piano_C#5.wav  | -natural      | Sets the natural note pitch. Use naturals and sharps ('#') only, not flats.  |
| _SW <code>&lt;note number&gt;</code> | piano_A2_SW40.wav              | -switch       | Sets the sample's switch point when used in multisample algorithms. The 'note number' is the MIDI note number, in decimal. |
| _RR <code>&lt;number&gt;</code>      | snare_RR1.wav<br>snare_RR2.wav | N/A           | Links files as round-robin variants of the same sample.  |
| _V <code>&lt;number&gt;</code>       | snare_V1.wav<br>snare_V2.wav   | N/A           | Sets up a velocity switched sample. The lowest-numbered _V is used for the lowest velocity.                                |
| _CK <code>&lt;number&gt;</code>      | amen_CK8.wav                   | -clocks       | Sets the number of clocks per loop for the Clocked Audio Playback algorithm.   |
| _TR <code>&lt;number&gt;</code>      | funky_TR4.wav                  | -triggers     | The number of triggers per loop.   |
| _RP                                  | loop_RP.wav                    | -ramp=1       | Rising ramp.   |
| _RN                                  | loop_RN.wav                    | -ramp=-1      | Falling ramp.  |

If round-robins and velocity switches are combined, the velocity switch comes first e.g.

snare\_V1\_RR1.wav, snare\_V1\_RR2.wav  
snare\_V2\_RR1.wav, snare\_V2\_RR2.wav

In other words, each velocity layer can have round-robins.

### **Per-algorithm defaults**

Note that unlike on the disting mk4, where all algorithms use the same default values for playlist settings, the disting EX algorithms may have different defaults. These are noted in the documentation of each algorithm.

### **Automatic '-natural' values**

For the SD Multisample algorithm, if sample files are not assigned a natural pitch (for example, a folder of drum samples), they are assigned values from 48 upwards, so playing a keyboard chromatically from C3 will play a new sample on each semitone.

### **Automatic '-switch' calculation**

If the -switch point for multisample files is not explicitly specified, the disting EX calculates sensible defaults, as follows.

If the gap between neighbouring samples is at most 3 semitones, the switch is set so that the higher

sample is pitched down within the gap.

For larger gaps, the lower sample is pitched up over half the remaining range.

For example:

| Gap between samples (semitones) | Behaviour   |
|---------------------------------|---|
| 1                               | Higher sample stretched down over 1                                   |
| 2                               | Higher sample stretched down over 2                                   |
| 3                               | Higher sample stretched down over 3                                   |
| 4                               | Higher sample stretched down over 3; lower sample stretched up over 1 |
| 5                               | Higher sample stretched down over 4; lower sample stretched up over 1 |
| 6                               | Higher sample stretched down over 4; lower sample stretched up over 2 |
|                                 | Etc.  |

## New playlist flags

The disting EX defines some new playlist flags beyond those documented for the disting mk4.

These are as follows:

| Flag              | Default | Description   |
|-------------------|---------|---|
| -endLoopOnRelease | 0       | In the SD Multisample algorithm, if this flag is set to 1, and the sample defines loop points and is looping, when the note is released looping will be disabled and playback will continue to the end of the sample. |

## Loop markers in audio files

The disting supports reading loop information embedded in the WAV file. If this information is not present, or is disabled with the playlist option, any mode that loops the sample simply loops the whole file.

The disting EX looks for 'cue' chunks ([specification](https://sites.google.com/site/musicgapi/technical-documents/wav-file-format#cue)<sup>73</sup>) and 'smpl' chunks ([specification](https://sites.google.com/site/musicgapi/technical-documents/wav-file-format#smpl)<sup>74</sup>). Which of these your files contain will depend on the authoring software.

When interpreting a 'cue' chunk, loops are inferred either from markers or regions, as follows:

|                                 |  |
|---------------------------------|--|
| 1 marker point in file          | Marker is assumed to be loop start; loop is from the marker to the end of the sample.  |
| 2 marker points in file         | Markers are used as loop start and end.  |
| 3 or more marker points in file | First marker is ignored (assumed to be playback start point); second and third markers used as loop points. Remaining markers ignored. |
| 1 or more regions in file       | First region is used as the loop; other regions and markers ignored.   |

<sup>73</sup> <https://sites.google.com/site/musicgapi/technical-documents/wav-file-format#cue>

<sup>74</sup> <https://sites.google.com/site/musicgapi/technical-documents/wav-file-format#smpl>

This video illustrates the use of cue points as loop markers:

[Video](#) 

When interpreting a 'smpl' chunk, the first loop in the chunk is used, and any others are ignored.

## Wavetables

Wavetables are installed and formatted on the MicroSD card exactly as they are on the disting mk4. The card provided with the disting EX has a wide selection of wavetables pre-installed.

For convenience, the relevant section of the disting mk4 user manual is reproduced here:

All wavetable files need to be in a top-level folder on the SD card called 'wavetables'.

Within the 'wavetables' folder, wavetables can take of one two forms: a single WAV file containing all the waveforms concatenated, or a folder of WAV files, one per waveform.

By default the disting will consider all WAV files and folders of WAV files in the 'wavetables' folder as wavetables. Optionally (say if you want to reorder the tables) you can specify a playlist: the wavetables are then listed in the standard playlist format as above, but with the dedicated name "playlist-wavetable.txt". Each entry is either a WAV file (as in the other playlist formats), in which case the file is assumed to contain all the waveforms concatenated, or a folder name.

If a folder is specified in "playlist-wavetable.txt", the folder contains the individual WAV files that represent one waveform each. The algorithm does not use any 'playlist.txt' file within the folder – any files found files are used in alphabetical order.

Waveform WAVs must be in 16 bit mono format. The sample rate is unimportant, since the file is assumed to contain exactly one cycle and so can pitched arbitrarily.

When using a single concatenated WAV file, the disting needs to be know how many frames in the file make up one waveform. This is specified in the playlist via the -wavelength setting (default 600). There are no settings that apply to wavetable folders, nor to the individual files inside the folders.

To reiterate – the use of playlists is entirely optional if your wavetables are in the form of folders of individual waveform files.

# Settings

The Settings menu provides access to some global settings which are not part of a preset. These settings are stored when changed and reapplied when the module powers up.

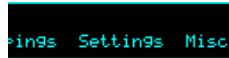

## General

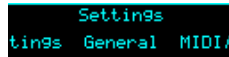

The Settings->General menu contains these settings:

| Setting                             | Value range | Default | Function  |
|-------------------------------------|-------------|---------|---|
| Contrast                            | 0-255       | 127     | Sets the display contrast/brightness.   |
| Display blank                       | 1-30        | 15      | The time in minutes after which the display will be turned off, if idle, in order to extend the display's lifespan.   |
| Display flip                        | 0-1         | 0       | Turns the display upside down.  |
| Dual display mode                   | 0-2         | 0       | The display mode when in dual mode – see above.   |
| Startup preset                      | -1 – 256    | -1      | The preset number to load at startup, or '0' for none. The value '-1' enables the Auto-save feature (see above).  |
| Startup mapping                     | 0-64        | 0       | The mapping number to load at startup, or '0' for none.   |
| Auto(-change) startup preset        | 0-1         | 0       | If enabled, saving or loading a preset automatically changes the 'Startup preset' setting, so that the module will load the most recently saved/loaded preset when it next powers up.   |
| Auto save (when) change alg(orithm) | 0-1         | 0       | If enabled, whenever you change algorithm (in single or dual mode), the preset will be saved to preset slot 1. If you also set the startup preset to 1, this means the module will power up with the most recently chosen algorithm(s). |
| Knob param threshold                | 0-256       | 48      | Sets how much the 'R' knob has to be turned to take over parameter or menu value changes.   |
| Gate CV threshold                   | 1-1000      | 100     | The threshold for gate CVs in algorithms that use CV/gate pairs to play notes e.g. SD Multisample. The value is in multiples of 10mV (i.e. the default is 1V).  |
| Buttons -> preset                   | 0-3         | 1       | Sets whether the 'L' and 'R' buttons step through the presets for the current algorithm. The options are 'Off', 'L next', 'L next, R previous', and 'R next, L previous'.   |
| Enable High Speed SD                | 0-1         | 1       | See 'Supported MicroSD cards', above.   |
| Wake on MIDI/I2C                    | 0-3         | 0       | Sets whether incoming MIDI or I2C messages wake the display, if it is turned off.   |



| Setting               | Value range | Default | Function  |
|-----------------------|-------------|---------|---|
| Accessibility         | 0-1         | 0       | When set to 1, the module sends accessibility SysEx messages when the encoders and knob buttons are operated. |
| Enable display zoom   | 0-20        | 0       | Enables display zoom in single mode. See above.   |
| Enable second display | 0-3         | 0       | Enables a second display attached to the FHX expander header. See below. Requires a reboot to take effect.    |

## Second display

It is possible to add a second, external display to the module. This is something of a DIY project - please see [here](#)<sup>75</sup> for more details. The options for the 'Enable second display' setting are as follows:

| Value | Name               | Description   |
|-------|--------------------|---|
| 0     | Off                | The second display is not used.   |
| 1     | On                 | The second display mirrors the module's own display.  |
| 2     | Visuals on primary | For algorithms which have visuals (usually accessed by double-clicking V), always show the visuals on the module's own display. |
| 3     | Visuals on 2nd     | For algorithms which have visuals (usually accessed by double-clicking V), always show the visuals on the second display.       |

## MIDI/I2C page 1

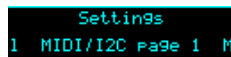

This menu contains settings relating to MIDI or I2C communication.

| Setting             | Value range | Default | Function  |
|---------------------|-------------|---------|---|
| Soft thru           | 0-3         | 0       | See below.  |
| RX channel (single) | 1-17        | 1       | The MIDI receive channel for single mode algorithms. The value '17' enables MPE <sup>76</sup> if the algorithm supports it. |
| TX channel (single) | 0-16        | 1       | The MIDI transmit channel for single mode algorithms. '0' means 'Off'.  |
| RX channel (dual L) | 1-16        | 1       | The MIDI receive channel for dual mode algorithms running on the left half.   |
| TX channel (dual L) | 0-16        | 1       | The MIDI transmit channel for dual mode algorithms running on the left half. '0' means 'Off'.                               |
| RX channel (dual R) | 1-16        | 2       | The MIDI receive channel for dual mode algorithms running on the right half.  |
| TX channel (dual R) | 0-16        | 2       | The MIDI transmit channel for dual mode algorithms running on the right half. '0' means 'Off'.                              |

<sup>75</sup> <https://expertsleepersltd.github.io/hardware/1U-display-adaptor/>

<sup>76</sup> MIDI Polyphonic Expression

| Setting                 | Value range | Default | Function   |
|-------------------------|-------------|---------|--|
| I2C address             | 0-127       | 49      | The module's I2C address.  |
| Select Bus function     | 0-3         | 3       | The function of the Select Bus – see below.  |
| Default first CC        | 0-127       | 7       | Sets which CC# to start at in the default MIDI mapping – see above.  |
| Show MIDI parameter     | 0-1         | 0       | If '1', when a MIDI CC is received that changes a parameter, the current parameter is switched to the changed one.             |
| Show I2C parameter      | 0-1         | 0       | If '1', when an i2c message is received that changes a parameter, the current parameter is switched to the changed one.        |
| Algorithm select CC     | -1 – 127    | -1      | Sets a MIDI CC number which will change the current (single mode) algorithm, or '-1' for 'Off'.                                |
| Program Change opt(ion) | 0-3         | 0       | Sets the interpretation of MIDI Program Change messages – see below. This applies to single and dual modes.                    |
| Send CCs                | 0-3         | 0       | When to send MIDI CCs on parameter changes. See 'MIDI Mappings', above.  |
| Learn is exclusive      | 0-1         | 1       | If '1', when a MIDI CC mapping is set via 'Learn', any conflicting mapping of the same CC is unset. Likewise for I2C mappings. |

## MIDI/I2C page 2

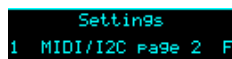

This menu contains further settings relating to MIDI or I2C communication.

| Setting              | Value range | Default | Function  |
|----------------------|-------------|---------|---|
| SysEx Device ID      | 0-126       | 0       | The SysEx device ID to respond to.  |
| Show SysEx parameter | 0-1         | 0       | If '1', when MIDI SysEx (message 46H) is received that changes a parameter, the current parameter is switched to the changed one. |
| Soft Takeover        | 0-1         | 0       | Enables 'soft takeover' on MIDI CCs. See below.   |

## MIDI Program Change options

The options for the 'Program Change opt' setting are as follows.

| Value | Name             | Description  |
|-------|------------------|--|
| 0     | Choose preset    | MIDI program change messages change the current preset.    |
| 1     | Choose algorithm | MIDI program change messages change the current algorithm. |
| 2     | Ignore           | MIDI program change messages are ignored.                  |

| Value | Name          | Description  |
|-------|---------------|--|
| 3     | Preset + bank | As '0', but additionally Bank Select messages (CC 0) are also recognised to access presets beyond the first 128. |

## Soft thru options

The options for the 'Soft thru' setting are as follows.

| Value | Name              | Description   |
|-------|-------------------|---|
| 0     | Off               | Soft thru disabled.   |
| 1     | To MIDI           | MIDI arriving at the module's MIDI in port will be immediately forwarded to its out port.                       |
| 2     | To Select Bus     | MIDI arriving at the module's MIDI in port will be immediately forwarded to the Select Bus.                     |
| 3     | Select Bus & MIDI | MIDI arriving at the module's MIDI in port will be immediately forwarded to its out port and to the Select Bus. |

Note that in all cases no attempt is made to correctly merge any MIDI that the module itself may generate with the MIDI being forwarded.

## Soft Takeover

If enabled in the Settings, the disting EX supports the familiar 'soft takeover' paradigm for MIDI CCs, where after loading a preset the controlling MIDI CC has to pass through the value that would set the current parameter value before assuming control. This avoids parameter jumps if the controller's physical position doesn't match that of the preset.

While this is happening, the display shows a message with the current controller value and the target value at which it will assume control:

```
TAKEOVER
164 1101
```

## Favourites

```
Settings
12C Favourites Cali
```

```
Favourites
Slot 0-1
S-3: LF0
```

This menu lets you set up the 'favourites' dual mode slots, numbered O-1 to P-8. These slots can be set up to point to any of the dual mode algorithms (A-1 to N-8), allowing convenient access to your most often used algorithms.

## Calibration

This menu contains functions relating to the calibration of the module. Note that the module is calibrated in the factory and should not need further calibration by the user.

The 'Calibrate' menu item enters the calibration process – see below for details. If you enter this mode by accident, pressing 'L' cancels it.

'View raw calibration' shows the raw data that the calibration process captures. This is intended for debugging purposes only.

'View input voltages' shows the voltages that the module is reading on its six inputs, with the calibration applied.

## Reset Settings

This menu item allows you to reset all settings to their factory defaults. Note that this includes the calibration – the module will need to be recalibrated if you do this.

## Miscellaneous functions

```
Settings Misc Algorit
```

Various functions that don't naturally fit anywhere else can be found under the 'Misc' menu.

### Show firmware version

Does what it says on the tin.

```
Misc
Show firmware version
```

```
Expert Sleepers
disting EX
Version v0.7
```

### Reboot

Reboots the module. Any unsaved changes will be lost.

```
Misc
ersion Reboot Show M
```

### Show MIDI history

```
Misc
Show MIDI history
```

```
RCh 1 PC 1
BCh 1 PC 1
RCh 1 PC 1
BCh 1 PC 1
```

```
RCh 1 On 65 100
BCh 1 Off 65 64
RCh 1 On 65 100
BCh 1 Off 65 64
```

Shows the last four MIDI messages received by the module (most recent at the bottom). At the start of each line is 'R' if the message was received on the Select Bus or 'B' if the message was received via the MIDI breakout.

### Show I2C history

```
Misc
Show I2C history S
```

```
I2C RX
E4 11 00 3F E0 11
00 3F E4 11 00 3F E0
```

Shows the last 16 bytes received on the I2C bus. The address byte is shown inverted.

### Show stats

```
Misc
Copy Show stats Save
```

Shows a whole bunch of numbers. For internal developer use.

### Save MTS dump to SD

```
Misc
Save MTS dump to SD
```

Saves the most recent MIDI tuning dump received by the module to the MicroSD card. The file is saved in the 'MTS' folder, which will be created if it does not already exist. The filename is created from the tuning name set by MTS, with the extension '.syx'. Note that this will save over any existing file already on the card with that name. The file content is simply a MIDI SysEx dump, and as such can be used with a computer based SysEx librarian or similar.

## Tests

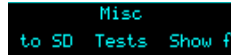

The 'Tests' menu provides a number of tests to exercise various parts of the module's hardware. They are mainly for factory use but are also useful to check if things are working correctly at any time.

The available tests are:

|                     |  |
|---------------------|--|
| Test outputs        | Outputs 1-4 output $\pm 10V$ sine waves at 100Hz, 200Hz, 500Hz and 1kHz respectively.  |
| Test inputs         | The module's screen shows an oscilloscope-like view of the input signal of one input at time. It automatically switches to show the active input. Full range on the display corresponds to an input voltage of $\pm 10V$ . |
| Test SRAM           | Tests the module's SRAM for integrity and displays a pass or fail message.   |
| Test ES-5           | Tests an attached ES-5 expansion module. The 8 LEDs on the ES-5 should light in sequence.  |
| Test FHX-8CV        | Tests an attached FHX-8CV expansion module. All 8 outputs of the FHX-8CV should show a full range ramp. The FHX-8CV's jumpers should be set to 'Expansion number 0' (no jumpers on).                                       |
| Test FHX-8GT        | Tests an attached FHX-8GT expansion module. The 8 LEDs on the FHX-8GT should light in sequence. The FHX-8GT's jumpers should be set to 'Expansion number 0' (no jumpers on).   |
| Test MIDI out       | Sends MIDI channel 1 CC #0 messages with a value ramping from 0 to 127 from the MIDI breakout's output.  |
| Test select bus out | Sends MIDI channel 1 CC #1 messages with a value ramping from 0 to 127 on the Select Bus.  |
| Test SD speed       | Performs a large number of reads from the SD card and presents the resulting timing information.   |
| Test ADCs           | Shows the values from the module's ADCs, which digitize the positions of the L and R knobs, and the CV and gate busses. Each row shows minimum, current, and maximum values. Press V to reset the minimum and maximum.     |
| Test Encoders       | Tests the push buttons of the two encoders and the two knobs.  |

## 5-pin DIN MIDI I/O

The disting EX has an expansion header on the PCB which can be used to add a pair of traditional 5-pin DIN MIDI ports to the module (one input/one output). This is compatible with the Expert Sleepers [MIDI breakout](#)<sup>77</sup>.

### Connections

The MIDI ports are exposed on a 4-pin expansion header (labelled GT4/MIDI) on the rear of the module. All of the necessary electronics are on the PCB; all that needs to be added is the actual sockets.

The header pin-out is as follows (pin 1 is closest to the 'GT4' text):

| Pin | Function  |
|-----|-----------|
| 1   | OUT pin 4 |
| 2   | OUT pin 5 |
| 3   | IN pin 5  |
| 4   | IN pin 4  |

Pin numbers refer to the 5-pin DIN socket as in the [MIDI specification](#)<sup>78</sup>.

The header is a standard 0.1" pitch header compatible with e.g. typical IDC cable sockets.

When using the Expert Sleepers MIDI breakout, pin 1 of the breakout's header (GT1) corresponds to pin 1 of the disting EX's header (GT4). Orient the ribbon cable to match up these pins. The supplied ribbon cable has two rows of four contacts – use the same row of four at each end.

### MIDI "Low-Voltage Signaling"

When MIDI was first conceived, standard logic circuits ran at 5V, and the initial hardware reference designs worked on this assumption. However, there is nothing in the MIDI standard that actually requires a specific voltage, since it operates as a current loop via an opto-isolator.

Nowadays it is much more common for logic to run at 3.3V or lower. The MIDI Manufacturers Association has now released a reference hardware design based on 3.3V, which they call the "Low-Voltage Signaling" standard, and it is this that the disting EX uses.

The disting EX is therefore fully compatible with any device that adheres strictly to the MIDI specification, but may not be with devices that play fast and loose with the spec and assume 5V.

Download the full MIDI electrical specification [here](#)<sup>79</sup>.

---

77 <http://expert-sleepers.co.uk/dm4midibreakout.html>

78 <https://www.midi.org/specifications/item/midi-din-electrical-specification>

79 <https://www.midi.org/specifications/item/midi-din-electrical-specification>

## MIDI System Exclusive (SysEx)

The disting EX supports a variety of features via MIDI System Exclusive messages.

The browser-based tools [here](#)<sup>80</sup> can be considered as informal documentation of these messages, as in most cases the messages only exist to support these tools.

### SysEx Header

All SysEx messages are prefixed with a manufacturer's ID, which is a unique series of hex bytes assigned by the MIDI Manufacturers Association. The Expert Sleepers ID is 00H 21H 27H, so all SysEx messages relating to Expert Sleepers hardware will begin

```
F0 00 21 27
```

Messages for the disting EX follow this with 5DH:

```
F0 00 21 27 5D
```

followed by the module's SysEx ID (see the Settings, above)

```
F0 00 21 27 5D <SysEx ID>
```

and then with a byte to identify the specific type of message e.g.

```
F0 00 21 27 5D <SysEx ID> 01
```

### 16 bit values

Where '16 bit value' is indicated below, this is a sequence of 3 bytes:

```
<most significant 2 bits> <middle 7 bits> <least significant 7 bits>
```

## Received SysEx messages

### 01H – Take screenshot

```
F0 00 21 27 5D <SysEx ID> 01 F7
```

This causes the disting EX to respond with a SysEx message containing a screenshot of what is currently on the module's display, using the '33H – Screenshot' format, below.

### 02H – Display message

```
F0 00 21 27 5D <SysEx ID> 02 <NULL terminated ASCII string> F7
```

Displays the enclosed string on the disting EX's screen.

### 22H – Request version string

```
F0 00 21 27 5D <SysEx ID> 22 F7
```

This causes the disting EX to respond with a SysEx message containing the module's version string as text, using the '32H – Message' format, below.

---

<sup>80</sup> [https://github.com/expertsleepersltd/distingEX\\_tools](https://github.com/expertsleepersltd/distingEX_tools)

## 40H – Request algorithm

```
F0 00 21 27 5D <SysEx ID> 40 F7
```

Requests the current algorithm number(s). Responds with '40h – Algorithm', as below.

## 41H – Request preset name

```
F0 00 21 27 5D <SysEx ID> 41 F7
```

Requests the current preset name. Responds with '41h – Preset name', as below.

## 42H – Request number of parameters

```
F0 00 21 27 5D <SysEx ID> 42 F7
```

Requests the number of parameters in the current algorithm. Responds with '42h – Number of parameters', as below.

## 43H – Request parameter info

```
F0 00 21 27 5D <SysEx ID> 43 <parameter number> F7
```

Requests information for the given parameter in the current algorithm. Responds with '43h – Parameter info', as below.

## 44H – Request all parameter values

```
F0 00 21 27 5D <SysEx ID> 44 F7
```

Requests the current values of all parameters in the current algorithm. Responds with '44h – All parameter values', as below.

## 45H – Request parameter value

```
F0 00 21 27 5D <SysEx ID> 45 <parameter number> F7
```

Requests the value of the given parameter in the current algorithm. Responds with '45h – Parameter value', as below.

## 46H – Set parameter value

```
F0 00 21 27 5D <SysEx ID> 46 <parameter number> <16 bit value> F7
```

Sets the value of the given parameter in the current algorithm.

## 47H – Set preset name

```
F0 00 21 27 5D <SysEx ID> 47 <16 byte ASCII string> F7
```

Sets the current preset name.

## 48H – Request unit strings

```
F0 00 21 27 5D <SysEx ID> 48 F7
```

Requests string descriptions of the possible parameter units (Hz, ms etc.). Responds with '48h – Unit strings', as below.



## 49H – Request enum strings

```
F0 00 21 27 5D <SysEx ID> 49 <parameter number> F7
```

Requests the value strings for an 'enum' type parameter. Responds with '49h – Enum strings', as below.

## 4AH – Set focus

```
F0 00 21 27 5D <SysEx ID> 4A <parameter number> F7
```

Sets the given parameter to be the currently active one in the module's display.

## 4BH – Request mapping

```
F0 00 21 27 5D <SysEx ID> 4B F7
```

Requests the current mapping. Responds with '4Bh – Mapping', as below.

## 4CH – Set mapping name

```
F0 00 21 27 5D <SysEx ID> 4C <16 byte ASCII string> F7
```

Sets the name of the current mapping.

## 4DH – Set mapping

```
F0 00 21 27 5D <SysEx ID> 4D <parameter number> <packed mapping data> F7
```

Sets the CV, knob, and button mapping for the given parameter.

## 4EH – Set MIDI mapping

```
F0 00 21 27 5D <SysEx ID> 4E <parameter number> <packed mapping data> F7
```

Sets the MIDI mapping for the given parameter.

## 4FH – Set I2C mapping

```
F0 00 21 27 5D <SysEx ID> 4F <parameter number> <packed mapping data> F7
```

Sets the I2C mapping for the given parameter.

## 60H – Algorithm-specific message

```
F0 00 21 27 5D <SysEx ID> 60 <algorithm> <algorithm-specific data> F7
```

A message to control something in a specific algorithm.

| Algorithm   | Message | Meaning       | Full example                                 |
|-------------|---------|---------------|--|
| Looper - 06 | 58      | Clear loop(s) | F0 00 21 27 5D <SysEx ID> 60 06 58 F7        |
| Looper - 06 | 59      | Get state     | F0 00 21 27 5D <SysEx ID> 60 06 59 <loop> F7 |

## 71H – Request screen as text

```
F0 00 21 27 5D <SysEx ID> 71 F7
```

This causes the module to respond with a SysEx message containing the text on the module's display, using the '72H – Screen as text' format, below.

## 73H – Request parameter name

```
F0 00 21 27 5D <SysEx ID> 73 F7
```

This causes the module to respond with a SysEx message containing the name of the current item being manipulated on the display, using the '75H – Parameter name' format, below.

## 74H – Request parameter value

```
F0 00 21 27 5D <SysEx ID> 74 F7
```

This causes the module to respond with a SysEx message containing the value of the current item being manipulated on the display, using the '76H – Parameter value' format, below.

## 77H – Accessibility text entry

```
F0 00 21 27 5D <SysEx ID> 77 <ASCII string> F7
```

If the current item (as per “Request parameter value”) is a name, this message sets the item to the provided string.

## 78H – Accessibility remote control

```
F0 00 21 27 5D <SysEx ID> 78 <event> F7
```

Simulates a button press or encoder turn.

|   |                     |
|---|---------------------|
| 1 | P Encoder Press     |
| 2 | P Encoder Turn CW   |
| 3 | P Encoder Turn CCW  |
| 4 | V Encoder Press     |
| 5 | V Encoder Turn CW   |
| 6 | V Encoder Turn CCW  |
| 7 | V Encoder Long Hold |
| 8 | L Knob Pressed      |
| 9 | R Knob Pressed      |

## Sent SysEx messages

### 32H – Message

```
F0 00 21 27 5D <SysEx ID> 32 <NULL terminated ASCII string> F7
```

This message is transmitted in response to any request for a string e.g the version string.

### 33H – Screenshot

```
F0 00 21 27 5D <SysEx ID> 33 00 <screenshot data> F7
```

This message is transmitted in response to a '01H – Take screenshot' message.

### 40H – Algorithm

```
F0 00 21 27 5D <SysEx ID> 40 <dual mode> <algorithm> <algorithm>  
(<algorithm name>) F7
```

Contains information about the current algorithm(s). The first byte is a flag: 0 for single mode, 1 for dual mode. The next two bytes are algorithm numbers (the second will be zero in single mode). If the module is currently in single mode, the algorithm name follows, as a null-terminated string.

### 41H – Preset name

```
F0 00 21 27 5D <SysEx ID> 41 <16 byte ASCII string> F7
```

Contains the current preset name (not null-terminated).

### 42H – Number of parameters

```
F0 00 21 27 5D <SysEx ID> 42 <number of parameters> F7
```

Contains the number of parameters in the current algorithm.

### 43H – Parameter info

```
F0 00 21 27 5D <SysEx ID> 43 <parameter number> <16 bit value> <16 bit  
value> <16 bit value> <unit> <ASCII string> F7
```

Contains information for the given parameter in the current algorithm. The three 16 bit values are the parameter's minimum, maximum and default values.

### 44H – All parameter values

```
F0 00 21 27 5D <SysEx ID> 44 [<16 bit value>] F7
```

Contains the current values of all parameters in the current algorithm.

### 45H – Parameter value

```
F0 00 21 27 5D <SysEx ID> 45 <parameter number> <16 bit value> F7
```

Contains the value of the given parameter in the current algorithm.

### 48H – Unit strings

```
F0 00 21 27 5D <SysEx ID> 48 <number of strings> [<ASCII string>] F7
```

Contains an array of string descriptions of the possible parameter units (Hz, ms etc.).

## 49H – Enum strings

```
F0 00 21 27 5D <SysEx ID> 49 <parameter number> <number of strings>
[<ASCII string>] F7
```

Contains the value strings for an 'enum' type parameter.

## 4BH – Mapping

```
F0 00 21 27 5D <SysEx ID> 4B <version> <mapping name> <num parameters>
<mapping data> <MIDI mapping data> <I2C mapping data> F7
```

Contains an entire mapping.

## 61H – Algorithm-specific message

```
F0 00 21 27 5D <SysEx ID> 61 <algorithm> <algorithm-specific data> F7
```

A message from a specific algorithm.

| Algorithm   | Message | Meaning    | Full example                                     |
|-------------|---------|------------|--|
| Looper - 06 | 59      | Loop state | F0 00 21 27 5D <SysEx ID> 61 06 59<br><state> F7 |

## 70H – Accessibility event

```
F0 00 21 27 5D <SysEx ID> 70 <event> <display mode> F7
```

This message is transmitted in response to user interaction. The event uses the same values as '78H – Accessibility remote control' above.

## 72H – Screen as text

```
F0 00 21 27 5D <SysEx ID> 72 <display mode> <4 x 32 ASCII characters>
F7
```

This message is transmitted in response to a '71H – Request screen as text' message.

## 75H – Parameter name

```
F0 00 21 27 5D <SysEx ID> 75 <ASCII string> F7
```

This message is transmitted in response to a '73H – Request parameter name' message.

## 76H – Parameter value

```
F0 00 21 27 5D <SysEx ID> 76 <item is a name?> <ASCII string> F7
```

This message is transmitted in response to a '74H – Request parameter value' message.

## Select Bus

The disting EX is capable of both sending and receiving on the Select Bus. Note that the jumper needs to be set appropriately as shown below:

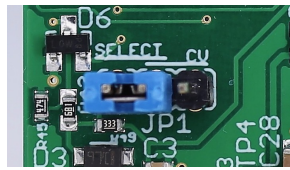

The Select Bus is a means of inter-module communication currently supported by a handful of modules from various manufacturers, including the [Malekko Varigate 8+](#)<sup>81</sup>, [Macro Machines Storage Strip](#)<sup>82</sup> and the [Make Noise Temp](#)<sup>83</sup> & [René 2](#)<sup>84</sup>.

The disting EX currently only responds to save/recall messages, by saving or loading a preset. It does not initiate anything, in this firmware version.

The message 'Select save' or 'Select load' will appear on the display if the module responds to a Select Bus save/recall.

Any MIDI that arrives on the Select Bus that is not explicitly part of the Select Bus protocol can be used as if it arrived on the disting's regular MIDI input – see above. This is controlled by the 'Select Bus function' setting (see Settings, above). The options are:

| Setting value | Setting           | Notes  |
|---------------|-------------------|--|
| 0             | Disabled          | The Select Bus is completely disabled.   |
| 1             | Only Select Bus   | Only Select Bus protocol messages (save & recall) will be processed.   |
| 2             | Only MIDI         | All MIDI arriving on the Select Bus (including Program Change messages that would normally indicate a save or recall) is used as regular MIDI. The Select Bus essentially becomes an additional MIDI input port. |
| 3             | Select Bus & MIDI | Select Bus save & recall messages are used as such; any other MIDI is used as regular MIDI messages.   |

The default is 'Select Bus & MIDI'.

81 <https://malekkoheavyindustry.com/product/varigate-8/>

82 <http://macromachines.net/products/storage-strip/>

83 <http://www.makenoisemusic.com/modules/tempi>

84 <http://makenoisemusic.com/modules/rene>

## I2C Connection

The disting EX supports an [I2C](#)<sup>85</sup> connection, via the header on the PCB marked “JP2”. The GND, SCL & SDA lines are clearly marked on the PCB. Be sure to connect these to the corresponding lines on the other I2C device(s) in use.

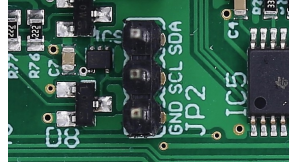

Make/remove I2C connections with the power off.

An I2C bus requires that somewhere on the bus are a pair of “pull up” resistors. The disting EX provides these on a switch labelled 'SW2':

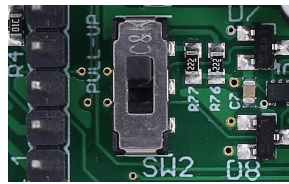

The pull up resistors are enabled if the switch is towards the power connector (as shown in the photo above), and disabled in the other position.

Devices on an I2C bus have an address, which a sending device uses to identify the intended recipient. The disting EX's address is set in the Settings (see above).

Currently the disting EX sends no messages on the I2C bus. It receives messages in the following format:

<address> <command> <optional bytes according to command>

A table of supported commands is below.

Some commands are “get” commands. The disting expects the get command to be followed immediately by a read of the requested data.

You may find the 'Show I2C history' menu item (above) helpful.



## Value ranges

Preset, algorithm & parameter numbers are 1-based.

Voltages (and related quantities e.g. pitch) are signed and scaled as 16384 ↔ 10V.

Velocities are 0-16384.

## Presets

### load preset

<address> 0x40 <preset number MSB> <preset number LSB>

<sup>85</sup> <https://en.wikipedia.org/wiki/I2C>

## **save preset**

<address> 0x41 <preset number MSB> <preset number LSB>

## **reset preset**

<address> 0x42

## **get current preset**

<address> 0x43

returns 2 bytes

## ***Algorithms (single mode)***

### **load algorithm**

<address> 0x44 <algorithm number>

### **get current algorithm**

<address> 0x45

returns 1 byte

### **set i2c controller X to value Y**

<address> 0x11 <controller number> <value MSB> <value LSB>

These messages are used via the Mappings (see above) to control algorithm parameters.

### **set parameter X to value Y (using the actual parameter value)**

<address> 0x46 <parameter number> <value MSB> <value LSB>

### **set parameter X to value Y (using 0..16384 range)**

<address> 0x47 <parameter number> <value MSB> <value LSB>

The 0-16384 value range will be scaled to the actual parameter value range.

### **get current parameter value**

<address> 0x48 <parameter number>

returns 2 bytes

### **get parameter min**

<address> 0x49 <parameter number>

returns 2 bytes

### **get parameter max**

<address> 0x4A <parameter number>

returns 2 bytes

## ***Algorithm-specific***

### **WAV Recorder, start / stop recording**

<address> 0x4B <0 - stop, 1 - start>

### **WAV Recorder, start / stop playback**

<address> 0x4C <0 - stop, 1 - start>

### **Augustus Loop, set pitch**

<address> 0x4D <pitch MSB> <pitch LSB>

### **Augustus Loop, send clock**

<address> 0x4E

### **Looper, clear**

<address> 0x58

Performs an instant clear of the target loops.

### **Looper, get state**

<address> 0x59 <loop>

returns 1 byte

## ***MIDI / Select Bus***

### **send MIDI message**

<address> 0x4F <status> <optional data byte 0> <optional data byte 1>

### **send Select Bus message**

<address> 0x50 <status> <optional data byte 0> <optional data byte 1>

### ***Voice Control (for specified voice)***

These messages offer direct control over the 8 voices of the SD Multisample algorithm, for example.

### **set voice pitch for the specified voice**

<address> 0x51 <voice> <pitch MSB> <pitch LSB>

### **note on for the specified voice**

<address> 0x52 <voice> <velocity MSB> <velocity LSB>

### **note off for the specified voice**

<address> 0x53 <voice>



## ***Voice Control (note based)***

These messages in general behave in the same way as MIDI note on/off.

### **set voice pitch for note id**

<address> 0x54 <note id> <pitch MSB> <pitch LSB>

### **note on for specified note id**

<address> 0x55 <note id> <velocity MSB> <velocity LSB>

### **note off for specified note id**

<address> 0x56 <note id>

### **all notes off**

<address> 0x57

## ***Dual mode operations***

In the below, <side> takes the value 0 or 1. <side / parameter index> has the side in the top nybble and the parameter number in the lower nybble.

### **get current parameter value**

<address> 0x5A <side / parameter index>  
returns 1 byte

### **get parameter min**

<address> 0x5B <side / parameter index>  
returns 1 byte

### **get parameter max**

<address> 0x5C <side / parameter index>  
returns 1 byte

### **set parameter X to value Y (using the actual parameter value)**

<address> 0x5D <side / parameter index> <value>

### **set parameter X to value Y (using 0..16384 range)**

<address> 0x5E <side / parameter index> <value MSB> <value LSB>  
The 0-16384 value range will be scaled to the actual parameter value range.

### **get current algorithm**

<address> 0x5F <side>  
returns 1 byte

## **load algorithm**

<address> 0x60 <side> <algorithm number>

## **get current algorithms**

<address> 0x61

returns 2 bytes

## **load algorithms**

<address> 0x62 <algorithm number> <algorithm number>

## **load dual preset**

<address> 0x63 <side> <preset>

## **save dual preset**

<address> 0x64 <side> <preset>

## **take-over/release Z**

<address> 0x65 <side> <value 0-127, else release>

## **read Z pots**

<address> 0x66

returns 4 bytes (two 15 bit results)

## ***Other***

## **set ES-5 output**

<address> 0x67 <header 0-5> <8 bit value>

## Calibration

The calibration menu is accessed via the settings, as described above.

Calibration requires a 3V voltage reference. Any stable and accurate voltage source can be used. It's a good idea to let the whole system warm up for 5 minutes before calibrating to stabilise any temperature-dependent factors.

The process can be cancelled at any time by pressing the 'L' knob.

The procedure is as follows:

1. With the disting powered up and with nothing connected to it, use the menu to select 'Calibrate'.
2. Calibration will begin immediately.
3. Wait for the display to show 'Waiting: A->X B->Y'.
4. Using patch cables (as short as possible), connect the left output A to input X, and output B to input Y.
5. Press the 'P' encoder.
6. After a short delay, all four jack sockets should light up red. After another short delay, the display will show 'Waiting: 3V -> X'.
7. Remove the patch cables. Connect the 3V voltage reference to input X.
8. Repeat steps 6 & 7 for inputs Y & Z.
9. Remove the voltage reference, and repeat steps 3-8 for the right side.

All being well, the display will show 'Calibration complete', and the new calibration will be saved. If the calibration failed, the display will show 'Calibration failed' and the calibration stored in the settings will not be overwritten.

## Firmware Updates

[Video](#) 

The disting EX's firmware can be updated using a MicroSD card. (See 'Supported MicroSD cards' above.) The process is as follows:

- Download the firmware from the Expert Sleepers website.
- Unzip the download.
- Copy the file (which will be named something like 'distingEX\_1.0.0.hex') from the unzipped download to the root folder of a MicroSD card.
- Turn off the disting and insert the MicroSD card into the socket.
  - The exposed contacts of the card should face towards the display; the angled side of the card itself points up.
  - **You are advised to observe basic ESD (electrostatic discharge) precautions** - see for example [here](#)<sup>86</sup>. Don't be wearing a nylon sweater in an air conditioned room.
- Turn on the disting EX with the P knob pressed. It will go through the first stage of its startup sequence, showing the bootloader version number.
- Hold P until the display changes. If the module finds firmware files on the card, it will show 'Choose firmware to install:' and then a filename.
- Turn the 'V' knob to select the firmware you want to install, then press 'V' to begin the installation.
- The module should show the message “Flashing...” and a progress indicator.
- Finally it should show “Success! Press left encoder to reboot” at which point you can press 'P' to reboot or simply turn off the power.
- Any other message indicates a problem.

## Where to get help

Email, forum, and social media links can be found at the bottom of every page on [our website](#)<sup>87</sup>.

---

<sup>86</sup> <https://www.computerhope.com/esd.htm>

<sup>87</sup> <https://www.expert-sleepers.co.uk>

## Acknowledgments

The disting EX logo and boot animation were designed by Andrew Beltran.

The font used in the disting mk4 (and so also in the disting EX's 'retro' mode) is an adapted version of 'Tom Thumb' by Robey Pointer. More on the font [here](#)<sup>88</sup>.

Much of the I2C implementation was developed in collaboration with [scanner darkly](#)<sup>89</sup>.

The Looper algorithm was developed in collaboration with [Elinch](#)<sup>90</sup>.

The Filter Bank algorithm was developed in collaboration with [Jogging House](#)<sup>91</sup>.

The 24dB/oct VCF algorithm was written by Eddie Edwards at [Reanimator Ltd](#)<sup>92</sup>.

Thanks to Tim Burgess for help with screen reader accessibility for the HTML preset editor.

Thanks to Armin Heinrich for extensive beta testing of the Poly Wavetable and Multi FX algorithms.

Thanks to Simon Kirby for key input and beta testing of the Convolver algorithm.

---

88 <https://robey.lag.net/2010/01/23/tiny-monospace-font.html>

89 <https://github.com/scanner-darkly>

90 <https://elinch.bandcamp.com>

91 <https://jogginghouse.com>

92 <https://www.reanimator.ltd.uk/>